

[www.aketroniks.com.tr](http://www.aketroniks.com.tr)



TEKNOLOJİ HER YERDE  
**TECHNOLOGY IS EVERYWHERE**

**AKE TRONIC®**

**ELECTRONIC SYSTEMS**

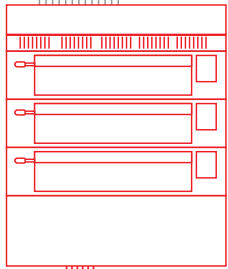

**FIRIN  
KONTROL ÜNİTELERİ  
CONTROLLERS FOR  
OVENS**

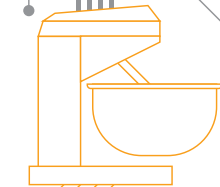

**HAZIRLIK GRUBU  
KONTROL ÜNİTELERİ  
CONTROLLERS FOR  
PREPARATION**



**BULAŞIK YIKAMA MAKİNESİ  
KONTROL ÜNİTELERİ  
CONTROLLERS FOR  
DISHWASHERS**



**SOĞUTMA GRUBU  
KONTROL ÜNİTELERİ  
CONTROLLERS FOR  
REFRIGERATION**

**AKE** TRONIC  
ELECTRONIC SYSTEMS



**AKE**



# “ Who is AKETRONIKS ? ” biz kimiz

1982 yılında KONYA ISI markası ile başlayan Endüstriyel Mutfak Ekipmanları üretimi serüvenimiz 35 yıldır aralıksız sürmektedir. Geçen 35 yılın sonucunda, kalitesinden ve müşteri memnuniyetinden taviz vermeyen anlayışımızla şirketimiz her geçen yıl istikrarlı büyümeye ve yatırımlarını sürdürmeye devam etmektedir.

2013 yılında başta endüstriyel mutfak ekipmanları ve soğutma sektöründe kullanılanlar olmak üzere, elektronik sistemlerin ar-ge, tasarım ve üretimini yapan AKETRONIKS LTD. ŞTİ. kurulmuş ve güçlü makine parkı ile ülkemizde çok zayıf olan gömülü (Embedded) elektronik sistemlerin üretimi konusunda dünya standartlarındaki fabrikasını kurmuştur. Ayrıca Mart 2018 tarihinden itibaren de T.C. Bilim ve Sanayi Bakanlığı tarafından onaylı AR-GE MERKEZİ olarak faaliyetlerine devam etmektedir.

2018 yılında, metal işleme kabiliyetlerimiz ile elektronik sistemlerin geliştirilmesi ve üretilmesindeki tecrübe- bilgi birikimlerimizi farklı sektörlerde de üretim yaparak AKE GROUP olarak devam ettirme karar almıştır.

Bu çerçevede son teknoloji metal işleme makinaları ve kart üretimine yönelik ilave makine yatırımları yapılmış, yeni sektör olarak da AKESec markası ile Kontrollü Geçiş Sistemlerinin üretimi ve AKEMED markası ile de medikal cihaz ve ekipmanları üretimi hedeflenmiştir.

Amacımız, 35 yıllık üretim tecrübemizle, uzman kadro ve deneyimli personelimizle, Müşteri memnuniyeti odaklı çalışma prensiplerimizle, verdiğimiz her sözün arkasında duran anlayışımızla sizlere yeni sektörlerde de en iyi şekilde hizmet etmektir.

Starting our business with KONYA ISI brand in 1982, our production of industrial kitchen equipments and refrigeration sector has been continuously running for 35 years. As a result of the last 35 years, our company continues to grow steadily every year and continue to invest by making no concessions to quality and customer satisfaction.

In 2013, AKETRONIKS LTD was established as a company which makes research&development, design and production of electronic systems, mainly used in industrial kitchen equipments. AKETRONIKS LTD, which has cutting-edge and powerful machine park, has world-class factory for the production of embedded electronic systems. Besides, AKETRONIKS LTD has continued its activities as R&D Center, which is approved by Ministry of Industry and Technology, since March 2018.

In 2018, we have decided to continue our production with our metal processing capabilities and experience in the development and production of electronic systems as AKE GROUP in different sectors.

In this context, the investments for metal processing machines and electronic board card production have been made and AKESec and AKEMED brands created as a new sector. We have targeted to manufacture Controlled Passing Systems with AKESec brand. And we've also targeted to manufacture medical devices and equipments with AKEMED brand.

Our aim is to serve you in the new sectors with our 35 years of production experience, expert and experienced staff, customer satisfaction oriented working principles and understanding of keeping all promises that we give our customers.

### “Our existence in market based upon..”

Increase customer investment value and also increase competition capacity as a solution partner.

### “Our target for future..”

As an constant purpose maintain continious expanding pattern with solution partners and to be known as strong information center with accumulation in electronic card technologies herewith being able to be known as worldwide engineer and electronic design brand.

Aketroniks, aim to increase comfort and promote to produce rationally throughout the world along with that promise to supply high quality and services on our products.

Also by continiously following the pioneer innovations and value creation we dedicate ourselves to develop the industry and ease the production process.

By knowing our responsibility to be productive leader in environment and the value sharing of our staff we dedicate ourself to spend our effort and sources to new worths for customers as Aketroniks, we want to create exciting and promotive future for all.

Embracing social responsibility principles of our firm comprise business ethics, organization, workers, suppliers, customers and overall society protective principls in general.

### “Var olma nedenimiz”

Müşterisinin yatırımına değer katan ve rekabet gücünü artıran bir çözüm ortağı olmaktır.

### “Yann için hedeflerimiz”

Çözüm ortakları ile sürekli büyüyen, elektronik kart teknolojilerindeki birikimleri ile bilgi merkezi olarak bilinen, ürettiği projelerle dünyada kabul gören mühendislik ve elektronik kart üretim markası olmaktır.

Aketroniks, dünyanın her yerindeki müşterileri için rahatlığı arttıran ve daha akılcı üretim yapmayı teşvik eden kaliteli ürünler ve hizmetler sunmayı taahhüt etmektedir.

Çığır açan yenilikleri ve değer yaratmayı sürekli olarak takip ederek, kendini üreten sanayiye geliştirmeye ve üretimi kolaylaştırmaya adanmıştır.

Elektronik kart alanında çevremizdeki üretken bir lider olma sorumluluğumuzu bilerek çalışanlarımızın paylaştığı değerleri, çaba ve kaynaklarımızı müşterilere yeni değerler sunmaya adanmış bulunmaktayız. Aketroniks'te hep birlikte heyecan ve ümit verici bir gelecek oluşturmak istiyoruz.

Sosyal sorumluluk ilkelerine sahip firmamızın iş etiği kuralları, kurumu, çalışanı, tedarikçiyi, tüketiciyi ve daha büyük çerçevede toplumu koruyacak ilkeleri kapsar.



# WHY AKETRONIKS? NEDEN AKETRONİKS

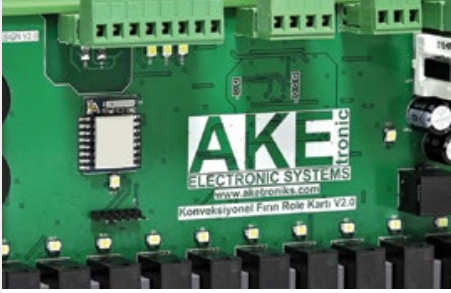

## Material Quality

We do not make concessions to branded, original and guaranteed materials for each product we use.

## Malzeme Kalitesi

Kullandığımız her ürün için markalı, orijinal ve garantili malzemelerden taviz vermiyoruz.



## Barcoding and Product Tracking System

We value your corporate values. While applying serial number and barcode system for product follow-up, we challenge years with our quality equipment.

## Barkodlama ve Ürün Takip Sistemi

Kurumsal değerlerinizi önemsiyoruz. Ürünü takip amaçlı seri numarası ve barkod sistemi uygularken, kaliteli ekipmanlarımız ile yıllara meydan okuyoruz.



## Packing

We value every product regardless of the nature of the product. We pack your cards one by one to ease the difficulties during the transportation and storage.

## Paketleme

Ürünün niteliğine bakılmaksızın her ürüne değer veriyoruz. Taşınma, depolama anındaki sıkıntılarınızı gidermek için kartlarınızı tek tek paketliyoruz.

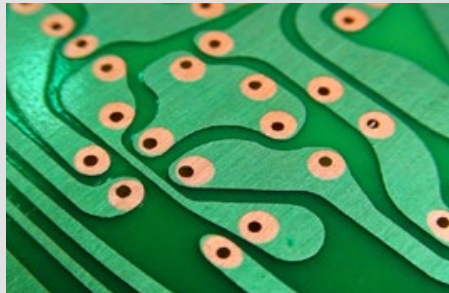

## PCB Coating

We protect your electronic cards so that you can work smoothly in bad environment conditions such as humidity and dust

## PCB Kaplama

Nem, toz gibi kötü ortam şartlarında sorunsuz çalışabilmeniz için elektronik kartlarınızı koruyoruz.

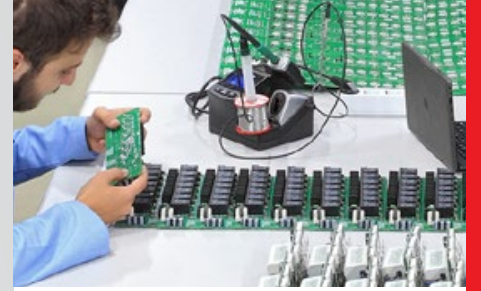

## Testing Process

Every product produced in Aketroniks has to pass through challenging test stages.

## Test Süreci

Aketroniks'te üretilen her ürün, zorlu test aşamalarından geçmek zorundadır.



## User Manual

We prepare the user manual for the cards in a detailed and understandable manner.

## Kullanım Kılavuzu

Kartların kullanım kılavuzunu ayrıntılı ve anlaşılır bir şekilde sizler için hazırlıyoruz.



## Delivery Term

Your procurement term is under our guarantee with the resource management programs we are using!

## Teslim Süresi

Kullanmakta olduğumuz kaynak yönetim programları ile tedarik süreniz garantimiz altındadır!



Aketroniks, sektöründe sürekli fark yaratmayı, ürünleri ve sahip olduğu teknolojilerle sektör lideri olmayı amaç edinmiştir. Üretimde kaliteyi en üst seviyeye çıkarmak için en son teknolojiye sahip üretim hattında büyük yatırımlara imza atmıştır. Ar-Ge nin önemini bilen ve bu doğrultuda çalışmalarını en üst seviyede tutan Aketroniks, 5746 no'lu Ar-Ge ve Tasarım Merkezlerinin desteklenmesine ilişkin kanun kapsamında Ar-Ge Merkezi olarak tescil edilerek Türkiye'deki sayılı Ar-Ge merkezlerinden biri olmuştur.



T.C. MINISTRY OF SCIENCE, INDUSTRY AND TECHNOLOGY

# APPROVED R&D CENTER

Aketroniks aimed to be the leader of the sector by committing to constantly making a difference in its industry, with its products and technologies. Aketroniks has made great investments in the latest technological production line to maximize production quality. Aketroniks, who knows the importance of R & D and keeps their work at the top level, was registered as R & D Center in Turkey under the law No. 5746.



EKRAN KARTI / DISPLAY CARD

AKE.343.501.01.01

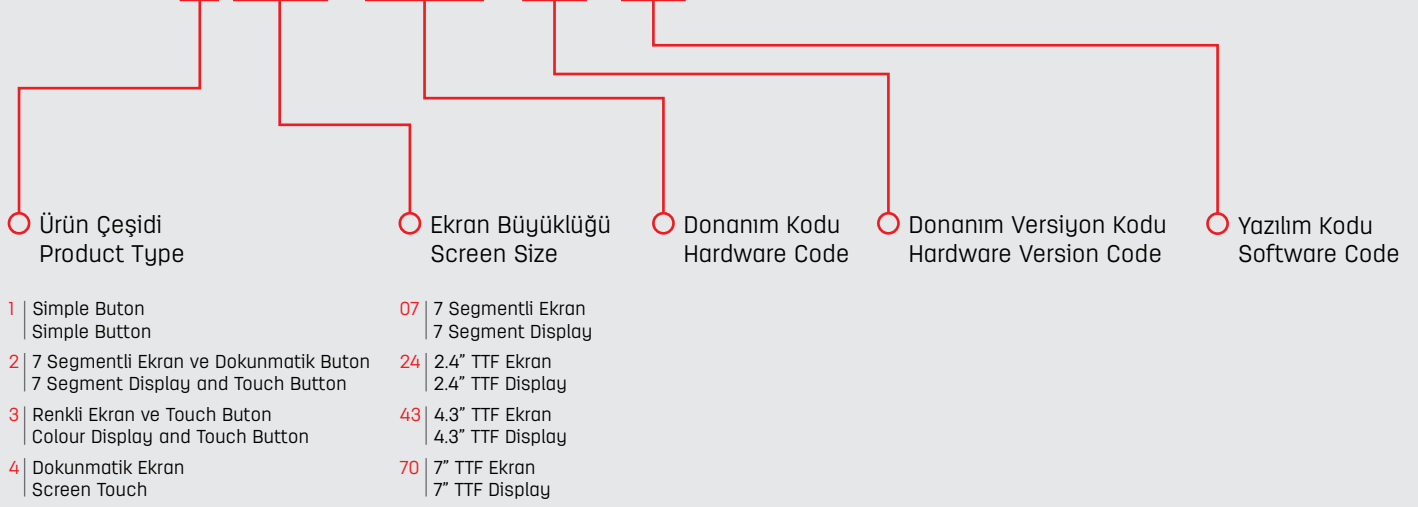

RÖLE KARTI / I/O CARD

AKE.R001.01.01

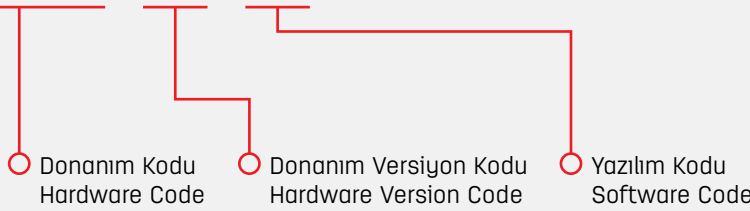

TEKNOLOJİ HER YERDE  
**TECHNOLOGY IN EVERYWHERE**



## İÇİNDEKİLER CONTENT

### Fınn Kontrol Üniteleri / Controllers For Ovens

<b>AKE.470.501.01.01</b>	Elektrikli Konveksiyonel Fınn Kontrol Ünitesi / Convection Oven Controller (Electrical)	14
<b>AKE.470.501.01.02</b>	Gazlı Konveksiyonel Fınn Kontrol Ünitesi / Convection Oven Controller (Gas)	14
<b>AKE.R009.01.01</b>	Elektrikli Konveksiyonel Fınn Röle Kartı / Convection Oven I/O Unit (Electrical)	14
<b>AKE.R010.01.01</b>	Gazlı Konveksiyonel Fınn Röle Kartı / Convection Oven I/O Unit (Gas)	14
<b>AKE.470.504.01.01</b>	Konveksiyonel Fınn Kontrol Ünitesi (Elektrikli-Gazlı) / Convection Oven Controller (Electrical-Gas)	16
<b>AKE.470.504.02.01</b>	Konveksiyonel Fınn Kontrol Ünitesi (Elektrikli-Gazlı) / Convection Oven Controller (Electrical-Gas)	16
<b>AKE.470.504.03.01</b>	Konveksiyonel Fınn Kontrol Ünitesi (Elektrikli-Gazlı) / Convection Oven Controller (Electrical-Gas)	16
<b>AKE.470.504.04.01</b>	Konveksiyonel Fınn Kontrol Ünitesi (Elektrikli-Gazlı) / Convection Oven Controller (Electrical-Gas)	16
<b>AKE.VM.01</b>	Wi-Fi modülü / Wi-Fi module	16
<b>AKE.470.505.01.01</b>	Kombi Fınn Kontrol Ünitesi (Elektrikli-Gazlı) / Combi Oven Controller (Electrical-Gas)	18
<b>AKE.470.505.02.01</b>	Kombi Fınn Kontrol Ünitesi (Elektrikli-Gazlı) / Combi Oven Controller (Electrical-Gas)	18
<b>AKE.470.505.03.01</b>	Kombi Fınn Kontrol Ünitesi (Elektrikli-Gazlı) / Combi Oven Controller (Electrical-Gas)	18
<b>AKE.470.505.04.01</b>	Kombi Fınn Kontrol Ünitesi (Elektrikli-Gazlı) / Combi Oven Controller (Electrical-Gas)	18
<b>AKE.VM.01</b>	Wi-Fi Modülü / Wi-Fi Module	18
<b>AKE.470.502.01.01</b>	Yemek Dağıtım Arabası Kontrol Ünitesi / Hot and Cold Trolley	20
<b>AKE.R011.01.01</b>	Yemek Dağıtım Arabası Röle Kartı / Hot and Cold Trolley I/O Unit	20
<b>AKE.370.501.01.01</b>	Elektrikli Döner Konveksiyonel Fınn Kontrol Ünitesi / Rotary Convection Oven Controller (Electrical)	22
<b>AKE.370.501.01.02</b>	Gazlı Döner Konveksiyonel Fınn Kontrol Ünitesi / Rotary Convection Oven Controller (Gas)	22
<b>AKE.370.501.01.03</b>	Elektrikli Konveksiyonel Fınn Kontrol Ünitesi / Convection Oven Controller (Electrical)	22
<b>AKE.370.501.01.04</b>	Gazlı Konveksiyonel Fınn Kontrol Ünitesi / Convection Oven Controller (Gas)	22
<b>AKE.R012.01.01</b>	Elektrikli Döner Konveksiyonel Fınn Röle Kartı / Rotary Convection Oven I/O Unit (Electrical)	22
<b>AKE.R013.01.01</b>	Gazlı Döner Konveksiyonel Fınn Röle Kartı / Rotary Convection Oven I/O Unit (Gas)	22
<b>AKE.R014.01.01</b>	Elektrikli Döner Konveksiyonel Fınn Röle Kartı / Rotary Convection Oven I/O Unit (Electrical)	22
<b>AKE.R015.01.01</b>	Gazlı Konveksiyonel Fınn Röle Kartı / Convection Oven I/O Unit (Gas)	22
<b>AKE.370.502.01.01</b>	Elektrikli Konveksiyonel Fınn Kontrol Ünitesi / Convection Oven Controller (Electrical)	24
<b>AKE.370.502.01.02</b>	Gazlı Döner Tabanlı Fınn Kontrol Ünitesi / Rotating Pizza Oven Controller (Gas)	24
<b>AKE.370.502.01.03</b>	Gazlı Sabit Tabanlı Fınn Kontrol Ünitesi / Pizza Oven Controller (Gas)	24
<b>AKE.R016.01.01</b>	Elektrikli Konveksiyonel Fınn Röle Kartı / Convection Oven I/O Unit (Electrical)	24
<b>AKE.R017.01.01</b>	Gazlı Döner Tabanlı Fınn Röle Kartı / Rotating Pizza Oven I/O Unit (Gas)	24
<b>AKE.R018.01.01</b>	Gazlı Sabit Tabanlı Fınn Röle Kartı / Pizza Oven I/O Unit (Gas)	24
<b>AKE.207.013.01.01</b>	Elektrikli Konveksiyonel Fınn Kontrol Ünitesi / Convection Oven Controller (Electrical)	26
<b>AKE.207.013.02.01</b>	Gazlı Konveksiyonel Fınn Kontrol Ünitesi / Convection Oven Controller (Gas)	26
<b>AKE.207.013.03.01</b>	Elektrikli Döner Konveksiyonel Fınn Kontrol Ünitesi / Rotary Convection Oven Controller (Electrical)	26
<b>AKE.207.013.04.01</b>	Gazlı Döner Konveksiyonel Fınn Kontrol Ünitesi / Rotary Convection Oven Controller (Gas)	26
<b>AKE.343.502.01.01</b>	Elektrikli Taş Tabanlı Fınn Kontrol Ünitesi / Deck Oven Controller (Electrical)	28
<b>AKE.R008.01.01</b>	Elektrikli Taş Tabanlı Fınn Röle Kartı / Deck Oven I/O Unit (Electrical)	28
<b>AKE.207.014.01.01</b>	Elektrikli Taş Tabanlı Fınn Kontrol Ünitesi / Deck Oven Controller (Electrical)	30
<b>AKE.207.015.01.01</b>	Elektrikli Taş Tabanlı Fınn Kontrol Ünitesi / Deck Oven Controller (Electrical)	32
<b>AKE.324.001.06.01</b>	Mayalandırma Makinesi Kontrol Ünitesi / Proofer Controller	34
<b>AKE.HTS.01</b>	Sıcaklık ve Nem Sensörü / Heat and Humidity Sensor	34
<b>AKE.207.016.01.01</b>	Mayalandırma Makinesi Kontrol Ünitesi / Proofer Controller	36
<b>AKE.324.005.01.01</b>	Elektrikli Konveksiyonel Fınn Kontrol Ünitesi / Convection Oven Controller (Electrical)	38
<b>AKE.324.006.01.01</b>	Elektrikli Konveksiyonel Fınn Kontrol Ünitesi / Convection Oven Controller (Electrical)	39
<b>AKE.207.006.01.01</b>	Elektrikli Konveksiyonel Fınn Kontrol Ünitesi / Convection Oven Controller (Electrical)	40
<b>AKE.207.007.01.01</b>	Elektrikli Konveksiyonel Fınn Kontrol Ünitesi / Convection Oven Controller (Electrical)	41
<b>AKE.207.008.01.01</b>	Döner Ekmek Fınnı Kontrol Ünitesi / Rotary Bread Oven Controller	42
<b>AKE.207.009.01.01</b>	Pizza Fınnı Kontrol Ünitesi / Pizza Oven Controller	43
<b>AKE.207.010.01.01</b>	Pizza Fınnı Kontrol Ünitesi / Pizza Oven Controller	44

### Hazırlık Grubu Kontrol Üniteleri / Controllers For Preparation

<b>AKE.343.501.01.01</b>	Mobil Mikser Kontrol Ünitesi / Mobile Mixer Controller	46
<b>AKE.R001.01.01</b>	Mobil Mikser Röle Kartı / Mobile Mixer I/O Unit	46
<b>AKE.324.001.01.01</b>	Hız Ayarlı Mikser Kontrol Ünitesi / Planetary Mixer Controller (Speed Controlled)	48
<b>AKE.324.001.02.01</b>	Üç Devirli Mikser Kontrol Ünitesi / Planetary Mixer Controller (3 Speed)	48
<b>AKE.324.001.03.01</b>	Çift Devirli Mikser Kontrol Ünitesi / Planetary Mixer Controller (2 Speed)	48
<b>AKE.324.001.04.01</b>	Tek Devirli Mikser Kontrol Ünitesi / Planetary Mixer Controller (1 Speed)	48
<b>AKE.324.001.05.01</b>	Spiral Hamur Yoğurma Makinesi Kontrol Ünitesi / Spiral Dough Mixer Controller	48
<b>AKE.324.002.01.01</b>	Hız Ayarlı Mikser Kontrol Ünitesi / Planetary Mixer Controller (Speed Controlled)	50
<b>AKE.324.002.02.01</b>	Üç Devirli Mikser Kontrol Ünitesi / Planetary Mixer Controller (3 Speed)	50
<b>AKE.324.002.03.01</b>	Çift Devirli Mikser Kontrol Ünitesi / Planetary Mixer Controller (2 Speed)	50
<b>AKE.324.002.04.01</b>	Tek Devirli Mikser Kontrol Ünitesi / Planetary Mixer Controller (1 Speed)	50
<b>AKE.324.002.05.01</b>	Spiral Hamur Yoğurma Makinesi Kontrol Ünitesi / Spiral Dough Mixer Controller	50
<b>AKE.207.001.01.01</b>	Hız Ayarlı Mikser Kontrol Ünitesi / Planetary Mixer Controller (Speed Controlled)	52
<b>AKE.207.001.02.01</b>	Üç Devirli Mikser Kontrol Ünitesi / Planetary Mixer Controller (3 Speed)	52

<b>AKE.207.001.03.01</b>	Çift Devirli Mikser Kontrol Ünitesi / Planetary Mixer Controller (2 Speed)	52
<b>AKE.207.001.04.01</b>	Tek Devirli Mikser Kontrol Ünitesi / Planetary Mixer Controller (1 Speed)	52
<b>AKE.207.001.05.01</b>	Spiral Hamur Yoğurma Makinesi Kontrol Ünitesi / Spiral Dough Mixer Controller	52
<b>AKE.207.002.01.01</b>	Çift Devirli Mikser Kontrol Ünitesi / Planetary Mixer Controller (2 Speed)	54
<b>AKE.207.002.02.01</b>	Çikolata Şelale Makinesi Kontrol Ünitesi / Chocolate Fountain Controller	54
<b>AKE.324.003.01.01</b>	Patates Soyma Makinesi Kontrol Ünitesi / Potato Peeler Controller	56
<b>AKE.324.004.01.01</b>	Patates Soyma Makinesi Kontrol Ünitesi / Potato Peeler Controller	58
<b>AKE.207.003.01.01</b>	Patates Soyma Makinesi Kontrol Ünitesi / Potato Peeler Controller	60
<b>AKE.207.004.01.01</b>	Kestart Makinesi Kontrol Ünitesi / Volumetric Dough Divider	62
<b>AKE.207.005.01.01</b>	Ara Dinlendirme Makinesi Kontrol Ünitesi / Dough Proofing Machine Controller	64

#### Bulaşık Yıkama Makinesi Kontrol Üniteleri / Controllers For Dishwashers

<b>AKE.324.501</b>	Bulaşık Yıkama Makinesi Kontrol Ünitesi Ekranı/Diswasher Controller Display	68
<b>AKE.R002.01.01</b>	Bulaşık Yıkama Makinesi Röle Kartı (Advance)/Diswasher I/O Unit (Advance)	68
<b>AKE.R003.01.01</b>	Bulaşık Yıkama Makinesi Röle Kartı (Premiun)/Diswasher I/O Unit (Premiun)	68
<b>AKE.R004.01.01</b>	Bulaşık Yıkama Makinesi Röle Kartı (Plus) /Diswasher I/O Unit (Plus)	68
<b>AKE.R004.02.01</b>	Bulaşık Yıkama Makinesi Röle Kartı/Diswasher I/O Unit	68
<b>AKE.207.501</b>	Bulaşık Yıkama Makinesi Kontrol Ünitesi Ekranı/Diswasher Controller Display	70
<b>AKE.R004.01.01</b>	Bulaşık Yıkama Makinesi Röle Kartı (Plus) /Diswasher I/O Unit (Plus)	70
<b>AKE.R004.02.01</b>	Bulaşık Yıkama Makinesi Röle Kartı/Diswasher I/O Unit	70
<b>AKE.107.501</b>	Bulaşık Yıkama Makinesi Kontrol Ünitesi Ekranı/Diswasher Controller Display	72
<b>AKE.R004.01.01</b>	Bulaşık Yıkama Makinesi Röle Kartı (Plus) /Diswasher I/O Unit (Plus)	72
<b>AKE.R004.02.01</b>	Bulaşık Yıkama Makinesi Röle Kartı/Diswasher I/O Unit	72
<b>AKE.R002.01.01</b>	Bulaşık Yıkama Makinesi Kontrol Ünitesi Advance / Dishwasher Controller Advance	74
<b>AKE.R003.01.01</b>	Bulaşık Yıkama Makinesi Kontrol Ünitesi / Dishwasher Controller	75
<b>AKE.R004.01.01</b>	Bulaşık Yıkama Makinesi Röle Kartı Plus / Dishwasher I/O Unit Plus	76
<b>AKE.R004.02.01</b>	Bulaşık Yıkama Makinesi Röle Kartı / Dishwasher I/O Unit	77
<b>AKE.ZR001.01.01</b>	Bulaşık Yıkama Makinesi Kontrol Ünitesi / Dishwasher Controller	78
<b>AKE.ZR001.02.01</b>	Bulaşık Makinesi Zaman Rölesi / Dishwasher Time Relay	79
<b>AKE.ZR002.01.01</b>	Bulaşık Makinesi Zaman Rölesi / Dishwasher Time Relay	80
<b>AKE.ZR003.01.01</b>	Bulaşık Makinesi Zaman Rölesi / Dishwasher Time Relay	81

#### Diğer Ürünler / Other Products

<b>AKE.207.011.01.01</b>	Sıcak Bânet Kontrol Ünitesi / Hot Banquette Controller	83
<b>AKE.107.001.01.01</b>	Vakumlama Makinesi Kontrol Ünitesi / Vacuuming Machine Controller	84
<b>AKE.200.001.01.01</b>	Trifaze Start-Stop Kontrol ünitesi / Three-Phase Start-Stop Controller	85
<b>AKE.200.002.01.01</b>	Monofaze Start-Stop Kontrol Ünitesi / Single-Phase Start-Stop Controller	86
<b>AKE.200.003.01.01</b>	Monofaze Start-Stop Kontrol Ünitesi / Single-Phase Start-Stop Controller	87
<b>AKE.200.004.01.01</b>	Monofaze Start-Stop Kontrol Ünitesi / Single-Phase Start-Stop Controller	88
<b>AKE.100.001.01.01</b>	Dijital Sıcaklık Göstergesi / Digital Temperature Indicator	89
<b>AKE.100.002.01.01</b>	100A SCR Modülü / 100A SCR Module	90
<b>AKE.100.003.01.01</b>	Tristör Modül Sürücü Ünitesi / Thyristor Module Driver Board	91
<b>AKE.100.004.01.01</b>	Analog Dimmer Kontrol Ünitesi / Analog Dimmer Controller	92
<b>AKE.HTS.01</b>	Mayalandırma Makinesi Isı ve Nem Sensörü / Proofer Heat and Humidity Sensor	93

#### Soğutma Grubu Kontrol Üniteleri / Controllers For Refrigeration

<b>AKE.C207.012</b>	Soğutucu Kontrol Ünitesi / Controller for Refrigeration	96
<b>AKE.C207.504</b>	Soğutucu Kontrol Ünitesi / Controller for Refrigeration	97
<b>AKE.C324.007</b>	Soğutucu Kontrol Ünitesi / Controller for Refrigeration	98
<b>AKE.C430.001</b>	Soğutucu Kontrol Ünitesi / Controller for Refrigeration	99
<b>AKE.C207.502</b>	Soğutucu Kontrol Ünitesi / Controller for Refrigeration	100
<b>AKE.C207.503</b>	Soğutucu Kontrol Ünitesi / Controller for Refrigeration	101
<b>AKE.C343.503</b>	Soğutucu Kontrol Ünitesi / Controller for Refrigeration	102
<b>AKE.C470.506</b>	Soğutucu Kontrol Ünitesi / Controller for Refrigeration	103
<b>AKE.C470.508</b>	Soğutucu Kontrol Ünitesi / Controller for Refrigeration	104
<b>AKE.R024.01.01</b>	Advanced Röle Kartı / Advanced I/O Unit	105
<b>AKE.R024.02.01</b>	Advanced Röle Kartı / Advanced I/O Unit	105
<b>AKE.R024.03.01</b>	Advanced Röle Kartı / Advanced I/O Unit	105
<b>AKE.R025.01.01</b>	Basic Röle Kartı / Basic I/O Unit	105
<b>AKE.R025.02.01</b>	Basic Röle Kartı / Basic I/O Unit	105
<b>AKE.R025.03.01</b>	Basic Röle Kartı / Basic I/O Unit	105
<b>AKE.PTD.01</b>	Parametre Aktarıcı Cihazı / Parameter Transfer Device	106
<b>AKE.MCK.01</b>	Modbus Dönüştürme Kiti / Modbus Converter	106
<b>AKE.HTS.01</b>	MODBUS Nem ve Sıcaklık Sensörü / MODBUS Humidity and Temperature Sensor	106
<b>AKE.NTC.01</b>	NTC	106
<b>AKE.FHK.01</b>	Fan Hız Kontrolü Ünitesi / Fan Speed Controller	106



AKE

121° 250

59° 100

%100

%100

%100

1

AKE

⬆️ ⬇️ ⬇️ ⬆️

# Fırın Kontrol Üniteleri Controllers For Ovens

Elektrikli Taş Tabanlı Fırın Kontrol Ünitesi  
Deck Oven Controller (Electrical)

Elektrikli Konveksiyonel Fırın Kontrol Ünitesi  
Convection Oven Controller (Electrical)

Gazlı Konveksiyonel Fırın Kontrol Ünitesi  
Convection Oven Controller (Gas)

Yemek Dağıtım Arabası Kontrol Ünitesi  
Hot and Cold Trolley

Döner Ekmek Fırını Kontrol Ünitesi  
Rotary Oven Controller

Pizza Fırını Kontrol Ünitesi  
Pizza Oven Controller

Mayalandırma Makinesi Kontrol Ünitesi  
Proofer Controller



# AKE.470.501



7"  
İnç / Inch



64K Renkli TFT Ekran  
Color TFT Screen



Dokunmatik Ekran  
Touch Screen



Android & IOS sistemleri ile  
Uzaktan Kontrol  
Remote monitoring  
via Android & IOS systems



AKE.R009.01.01 AKE.R010.01.01



Zarif ve şık tasarımlı  
kontrol paneli  
Elegant and stylish  
control panel



Müşteriye özel tasarım  
Customer specific  
design



Değiştirilebilir görsel  
tasarım  
Changeable visual  
design



USB üzerinden veri  
aktarabilme  
Data transfer feature  
via USB



99 adet reçete özelliği  
99 recipes features



Gerçek tarih ve  
zaman özelliği  
Real time calendar  
feature

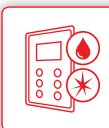

Darbeye dayanıklı, su  
geçirmez, ön panel  
Impact resistant, waterproof,  
front panel



Sesli uyan sistemi  
Audible caution  
system



Çalışma voltajı  
(24VAC)  
Operating voltage  
(24VAC)

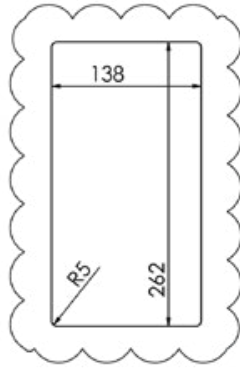

Kesim Ölçüleri / Cutting Dimensions

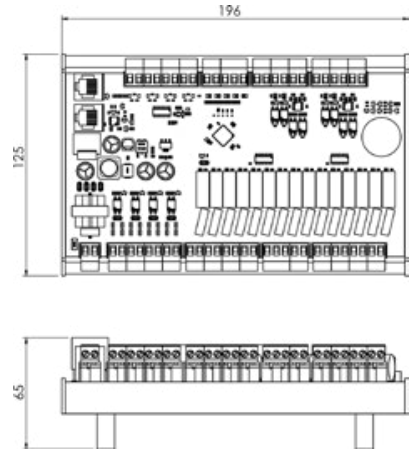
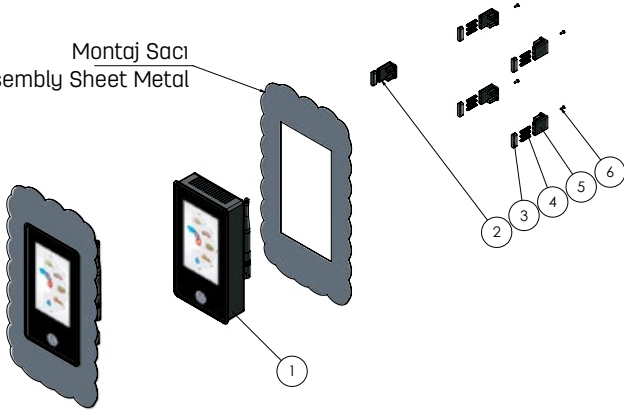
Montaj Sacı  
Assembly Sheet Metal

## Teknik Özellikler / Technical Specifications

- 7 inch, 480x800px çözünürlüklü, 16 milyon renkli dokunmatik TFT ekran
- 4 adet kuru kontak röle çıkışı (Max: 220VAC-5A)
- 11 (4+7) adet 2 ortak girişli röle çıkışı (Max: 220VAC-5A)
- 4 adet 0-10V analog çıkış
- 3 adet kuru kontak dijital çıkış
- 4 adet kuru kontak dijital giriş
- 4 adet termokupl girişi
- 2 adet NTC girişi
- 4 adet izolasyonlu anıza girişi
- 7 inch, 480x800px resolution, 16 million color touch TFT screen
- 4 units of dry contact relay output (Max: 220VAC-5A)
- 11 (4+7) units of 2 common input relay output (Max: 220VAC-5A)
- 4 units of 0-10V analog output
- 3 units of dry contact digital output
- 4 units of digital input
- 4 units of thermocouple input
- 2 units of NTC input
- 4 units of insulated failure input

Örnek uygulama alanları  
Application

Ürün Kodu Product Code	Ürün İsmi Product Name
AKE.470.501.01.01	Elektrikli Konveksiyonel Fırın Kontrol Ünitesi / Convection Oven Controller (Electrical)
AKE.470.501.01.02	Gazlı Konveksiyonel Fırın Kontrol Ünitesi / Convection Oven Controller (Gas)
AKE.R009.01.01	Elektrikli Konveksiyonel Fırın Röle Kartı / Convection Oven I/O Unit (Electrical)
AKE.R010.01.01	Gazlı Konveksiyonel Fırın Röle Kartı / Convection Oven I/O Unit (Gas)

Paket İçeriği  
Package ContentMontaj Aparatları  
Mounting ApparatusKullanma Kılavuzu  
User ManualsMinimum Sipariş Miktarı  
Minimum Order quantity

12 Ad./Pcs

# AKE.470.504



7"  
İnç / Inch



64K Renkli TFT Ekran  
Color TFT Screen



Dokunmatik Ekran  
Touch Screen



Android & IOS sistemleri ile  
Uzaktan Kontrol  
Remote monitoring  
via Android & IOS systems  
(Opsiyonel/Optional)



Fırın Yıkama Özelliği  
Oven Washing Feature  
(Opsiyonel/Optional)



Motor Hız Kontrol Özelliği  
Motor Speed Control  
(Opsiyonel/Optional)



AKE.R019.01.01 AKE.R020.01.01

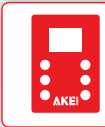

Zarif ve şık tasarımı  
kontrol paneli  
Elegant and stylish  
control panel



Müşteriye özel tasarım  
Customer specific  
design

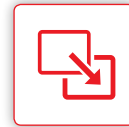

Değiştirilebilir görsel  
tasarım  
Changeable visual  
design



USB üzerinden veri  
aktarabilme  
Data transfer feature  
via USB



99 adet reçete özelliği  
99 recipes features



Gerçek tarih ve  
zaman özelliği  
Real time calendar  
feature



Darbeye dayanıklı, su  
geçirmez, ön panel  
Impact resistant, waterproof,  
front panel



Sesli uyan sistemi  
Audible caution  
system



3 aylık sıcaklık verilerini  
depolayabilme  
Ability to store temperature  
data for 3 months

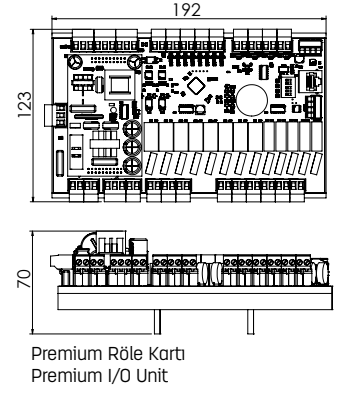
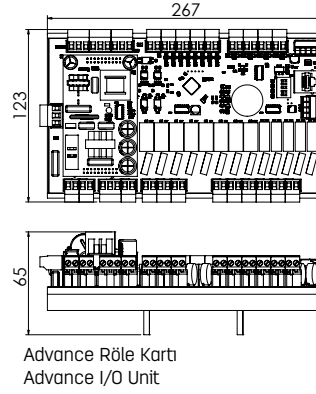
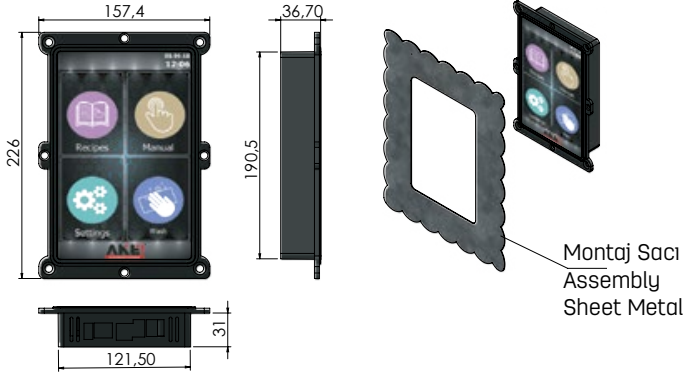

### Premium Röle Kartı Teknik Özellikler Premium I/O Unit Technical Specifications

- 5 adet ortak girişli röle çıkışı (Max: 220VAC-5A)
- 5 adet ortak girişli röle çıkışı (Max: 220VAC-10A)
- 3 adet kuru kontak röle çıkışı (Max: 220VAC-10A)
- 1 adet kuru kontak dijital çıkış
- 4 adet 0-10V analog çıkış
- 2 adet izolasyonlu anza girişi
- 4 adet termokupul / NTC girişi
- 1 adet PT 100 veya PT 1000 ısı probu girişi
- 8 adet kuru kontak dijital giriş veya 0-10V / 0-20mA analog giriş
- MODBUS haberleşme
- Sesli uyan sistemi
- 12VDC / 85-305VAC çalışma voltajı
- 5 units of common input relay output (Max:220VAC-5A)
- 5 units of common input relay output (Max:220VAC-10A)
- 3 unit of contact output (Max:220VAC-10A)
- 1 units of digital output
- 4 units of 0-10V analog output
- 2 units of insulated failure input
- 4 units of thermocouple / NTC input
- 1 unit of PT100 or PT1000 probe input
- 4 units of digital input or 0-10V / 0-20mA analog input
- MODBUS communication
- Alarm buzzer
- 12VDC / 85-305VAC operating voltage

### Advance Röle Kartı Teknik Özellikler Advance I/O Unit Technical Specifications

- 8+4 adet ortak girişli röle çıkışı (Max: 220VAC-5A)
- 4 adet kuru kontak röle çıkışı (Max: 220VAC-5A)
- 4 adet kuru kontak dijital çıkış
- 4 adet 0-10V veya 2 adet 0-20mA+2 adet 0-10V analog çıkış
- 3 adet izolasyonlu anza girişi
- 4 adet termokupul veya 2 adet termokupul+2 adet NTC girişi
- 12 adet kuru kontak dijital giriş veya 0-10V / 0-20mA analog giriş
- MODBUS haberleşme
- Fırın yıkama özelliği
- Sesli uyan sistemi
- 12VAC / 24VDC / 85-305VAC çalışma voltajı
- 8+4 units of common input relay output (Max:220VAC-5A)
- 4 unit of contact output (Max:220VAC-5A)
- 4 units of digital output
- 4 units of 0-10V or 2 units 0-20mA+2 units of 0-10V analog output
- 3 units of insulated failure input
- 4 units of thermocouple or 2 units of thermocouple+2 units of NTC input
- 12 units of digital input or 0-10V / 0-20mA analog input
- MODBUS communication
- Oven washing feature
- Alarm buzzer
- 12VAC / 24VDC / 85-305VAC operating voltage

### Örnek uygulama alanları Application



Döner konveksiyonel modeli de mevcuttur.  
Rotary convection model is available



Ürün Kodu Product Code	Ürün İsmi Product Name
AKE.470.504.01.01	Konveksiyonel Fırın Kontrol Ünitesi (Elektrikli-Gazlı) / Convection Oven Controller (Electrical-Gas) 7" HMI + Advance röle kartı + Yıkama özelliği / 7" HMI + Advance I/O Unit + Washing feature
AKE.470.504.02.01	Konveksiyonel Fırın Kontrol Ünitesi (Elektrikli-Gazlı) / Convection Oven Controller (Electrical-Gas) 7" HMI + Advance röle Kartı + Yıkama özelliği + Motor hız kontrol / 7" HMI + Advance I/O Unit + Washing feature + Motor speed control
AKE.470.504.03.01	Konveksiyonel Fırın Kontrol Ünitesi (Elektrikli-Gazlı) / Convection Oven Controller (Electrical-Gas) 7" HMI + Premium röle kartı / 7" HMI + Premium I/O Unit
AKE.470.504.04.01	Konveksiyonel Fırın Kontrol Ünitesi (Elektrikli-Gazlı) / Convection Oven Controller (Electrical-Gas) 7" HMI + Premium röle kartı + Motor hız kontrol / 7" HMI + Premium I/O Unit + Motor speed control
AKE.VM.01	Wi-Fi modülü *Data Log alma özelliği ve sistemi uzaktan takip etme özelliği standarttır. (Cihazı Wi-Fi ile internete bağlamak zorunludur) Not: Yukarıdaki özellikler haricindeki isteklerde yeni proje açılması gerekmektedir. Wi-Fi module *Log receiving function and remote monitoring function is a standart. (Connecting the device to internet is a necessity) Note: For other functions, we need to launch a project.

Paket İçeriği  
Package Content

Montaj Aparatları  
Mounting Apparatus



Kullanma Kılavuzu  
User Manuals



Minimum Sipariş Miktarı  
Minimum Order quantity

12 Ad./Pcs

# AKE.470.505



7"  
Inç / Inch



64K Renkli TFT Ekran  
Color TFT Screen



Dokunmatik Ekran  
Touch Screen



Android & IOS sistemleri ile  
Uzaktan Kontrol  
Remote monitoring  
via Android & IOS systems  
(Opsiyonel/Optional)



Fınn Yıkama Özelliği  
Oven Washing Feature  
(Opsiyonel/Optional)



Motor Hız Kontrol Özelliği  
Motor Speed Control  
(Opsiyonel/Optional)



AKE.R019.01.01 AKE.R020.01.01



Zarif ve şık tasarımlı  
kontrol paneli  
Elegant and stylish  
control panel

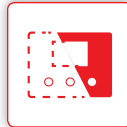

Müşteriye özel tasarım  
Customer specific  
design

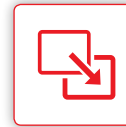

Değiştirilebilir görsel  
tasarım  
Changeable visual  
design



USB üzerinden veri  
aktarabilme  
Data transfer feature  
via USB



99 adet reçete özelliği  
99 recipes features



Gerçek tarih ve  
zaman özelliği  
Real time calendar  
feature

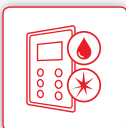

Darbeye dayanıklı, su  
geçirmez, ön panel  
Impact resistant, waterproof,  
front panel



Sesli uyan sistemi  
Audible caution  
system

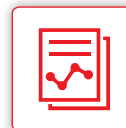

3 aylık sıcaklık verilerini  
depolayabilme  
Ability to store temperature  
data for 3 months

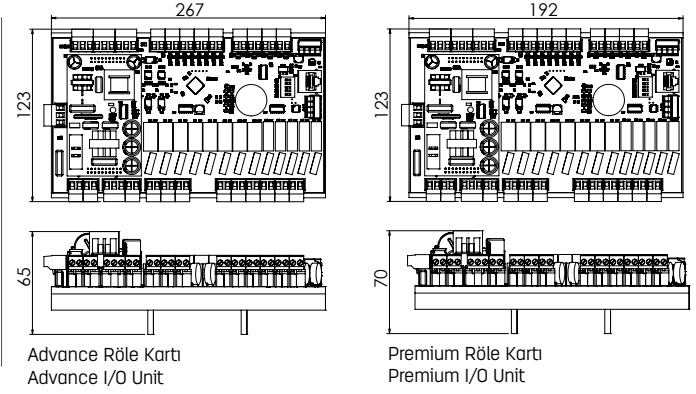
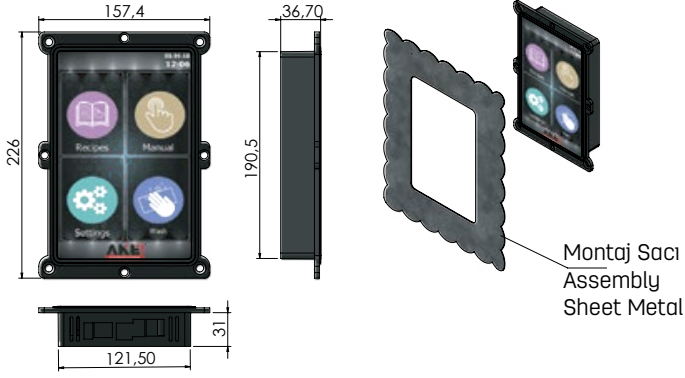

## Premium Röle Kartı Teknik Özellikler Premium I/O Unit Technical Specifications

- 5 adet ortak girişli röle çıkışı (Max: 220VAC-5A)
- 5 adet ortak girişli röle çıkışı (Max: 220VAC-10A)
- 3 adet kuru kontak röle çıkışı (Max: 220VAC-10A)
- 1 adet kuru kontak dijital çıkış
- 4 adet 0-10V analog çıkış
- 2 adet izolasyonlu anza girişi
- 4 adet termokupul / NTC girişi
- 1 adet PT100 veya PT1000 ısı probu girişi
- 8 adet kuru kontak dijital giriş veya 0-10V / 0-20mA analog giriş
- MODBUS haberleşme
- Sesli uyan sistemi
- 12VDC / 85-305VAC çalışma voltajı
- 5 units of common input relay output (Max:220VAC-5A)
- 5 units of common input relay output (Max:220VAC-10A)
- 3 unit of contact output (Max:220VAC-10A)
- 1 units of digital output
- 4 units of 0-10V analog output
- 2 units of insulated failure input
- 4 units of thermocouple / NTC input
- 1 unit of PT100 or PT1000 probe input
- 4 units of digital input or 0-10V / 0-20mA analog input
- MODBUS communication
- Alarm buzzer
- 12VDC / 85-305VAC operating voltage

## Advance Röle Kartı Teknik Özellikler Advance I/O Unit Technical Specifications

- 8+4 adet ortak girişli röle çıkışı (Max: 220VAC-5A)
- 4 adet kuru kontak röle çıkışı (Max: 220VAC-5A)
- 4 adet kuru kontak dijital çıkış
- 4 adet 0-10V veya 2 adet 0-20mA+2 adet 0-10V analog çıkış
- 3 adet izolasyonlu anza girişi
- 4 adet termokupul veya 2 adet termokupul+2 adet NTC girişi
- 12 adet kuru kontak dijital giriş veya 0-10V / 0-20mA analog giriş
- MODBUS haberleşme
- Fırın yıkama özelliği
- Sesli uyan sistemi
- 12VAC / 24VDC / 85-305VAC çalışma voltajı
- 8+4 units of common input relay output (Max:220VAC-5A)
- 4 unit of contact output (Max:220VAC-5A)
- 4 units of digital output
- 4 units of 0-10V or 2 units 0-20mA+2 units of 0-10V analog output
- 3 units of insulated failure input
- 4 units of thermocouple or 2 units of thermocouple+2 units of NTC input
- 12 units of digital input or 0-10V / 0-20mA analog input
- MODBUS communication
- Oven washing feature
- Alarm buzzer
- 12VAC / 24VDC / 85-305VAC operating voltage

## Örnek uygulama alanları Application



Ürün Kodu Product Code	Ürün İsmi Product Name
AKE.470.505.01.01	Kombi Fırın Kontrol Ünitesi (Elektrikli-Gazlı) / Combi Oven Controller (Electrical-Gas) 7" HMI + Advance röle kartı + Yıkama özelliği / 7" HMI + Advance I/O Unit + Washing feature
AKE.470.505.02.01	Kombi Fırın Kontrol Ünitesi (Elektrikli-Gazlı) / Combi Oven Controller (Electrical-Gas) 7" HMI + Advance röle Kartı + Yıkama özelliği + Motor hız kontrol 7" HMI + Advance I/O Unit + Washing feature + Motor speed control
AKE.470.505.03.01	Kombi Fırın Kontrol Ünitesi (Elektrikli-Gazlı) / Combi Oven Controller (Electrical-Gas) 7" HMI + Premium röle kartı / 7" HMI + Premium I/O Unit
AKE.470.505.04.01	Kombi Fırın Kontrol Ünitesi (Elektrikli-Gazlı) / Combi Oven Controller (Electrical-Gas) 7" HMI + Premium röle kartı + Motor hız kontrol / 7" HMI + Premium I/O Unit + Motor speed control
AKE.VM.01	Wi-Fi modülü *Data Log alma özelliği ve sistemi uzaktan takip etme özelliği standarttır. (Cihazı Wi-Fi ile internete bağlamak zorunludur) Not: Yukarıdaki özellikler haricindeki isteklerde yeni proje açılması gerekmektedir.

Paket İçeriği  
Package Content

Montaj Aparatları  
Mounting Apparatus



Kullanma Kılavuzu  
User Manuals



Minimum Sipariş Miktarı  
Minimum Order quantity

12 Ad./Pcs

# AKE.470.502



7"  
Inç / Inch



64K Renkli TFT Ekran  
Color TFT Screen



Dokunmatik Ekran  
Touch Screen



Android & IOS sistemleri ile  
Uzaktan Kontrol  
Remote monitoring  
via Android & IOS systems



## AKE.R011.01.01

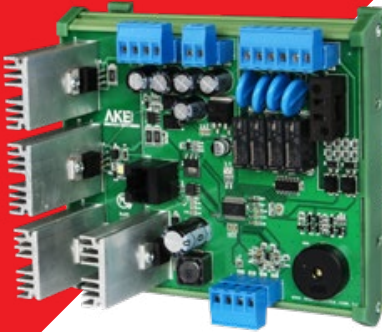

Zarif ve şık tasarımlı  
kontrol paneli  
Elegant and stylish  
control panel



USB üzerinden veri  
aktarabilme  
Data transfer feature  
via USB

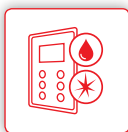

Darbeye dayanıklı, su  
geçirmez, ön panel  
Impact resistant, waterproof,  
front panel



Dahili akü sayesinde elektrik  
beslemesi olmadan çalışma  
Operation with battery  
backup



Müşteriye özel tasarım  
Customer specific  
design



50 adet reçete özelliği  
50 recipes features



Sesli uyan sistemi  
Audible caution  
system



1 yıllık sıcaklık verilerini  
depolayabilme  
Ability to store temperature  
data for 1 year



Değiştirilebilir görsel  
tasarım  
Changeable visual  
design



Gerçek tarih ve  
zaman özelliği  
Real time calendar  
feature



Esnek çalışma voltajı  
(12-24VAC)  
Flexible operating voltage  
(12-24VAC)

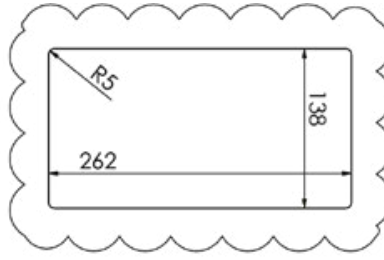
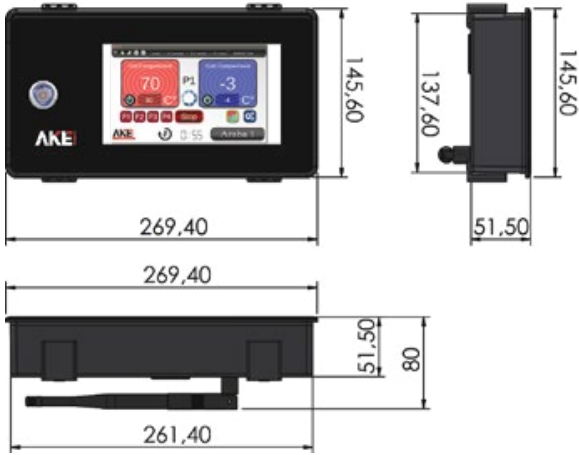

Kesim Ölçüleri / Cutting Dimensions

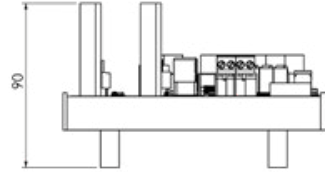
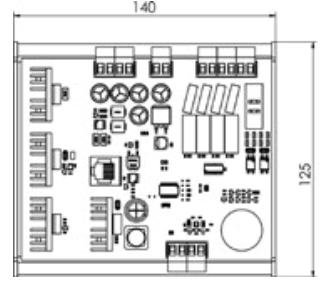

## Teknik Özellikler / Technical Specifications

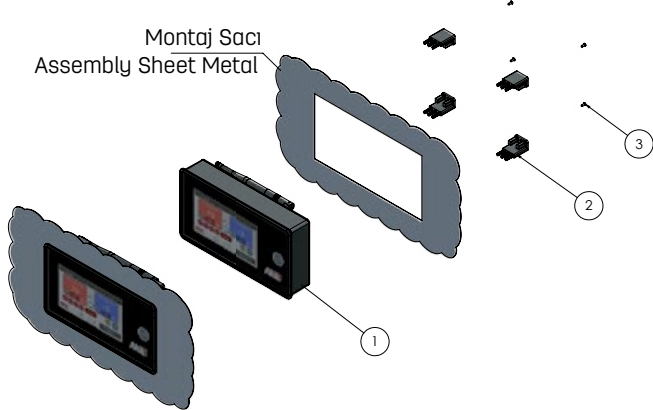

- 7 inch, 480x800px çözünürlüklü, 16 milyon renkli dokunmatik TFT ekran
- 1 adet led aydınlatmalı donanımsal buton
- 4 adet ortak girişli röle çıkışı (Max: 220VAC-5A)
- 1 adet NTC girişi
- 1 adet termokupl girişi
- 12-24V çalışma voltajı
- Sesli uyan sistemi
- 7 inch, 480x800px resolution, 16 million color touch TFT screen
- 1 unit of led illuminated hardware button
- 4 units of common input relay output (Max: 220VAC-5A)
- 1 unit of NTC input
- 1 unit of thermocouple input
- 12-24V operating voltage
- Alarm buzzer

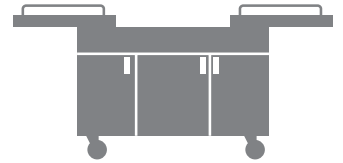
Örnek uygulama alanları  
Application

Ürün Kodu Product Code	Ürün İsmi Product Name
AKE.470.502.01.01	Yemek Dağıtım Arabası Kontrol Ünitesi / Hot and Cold Trolley
AKE.R011.01.01	Yemek Dağıtım Arabası Röle Kartı / Hot and Cold Trolley I/O Unit

Paket İçeriği  
Package ContentMontaj Aparatları  
Mounting ApparatusKullanma Kılavuzu  
User ManualsMinimum Sipariş Miktarı  
Minimum Order quantity

12 Ad./Pcs

# AKE.370.501



7"  
İnç / Inch



64K Renkli TFT Ekran  
Color TFT Screen



Dokunmatik Buton  
Touch Button



## AKE.R012.01.01

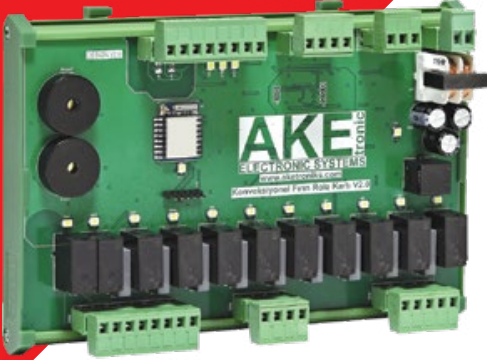

Zarif ve şık tasarımı  
kontrol paneli  
Elegant and stylish  
control panel

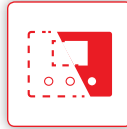

Müşteriye özel tasarım  
Customer specific  
design

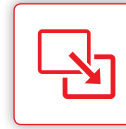

Değiştirilebilir görsel  
tasarım  
Changeable visual  
design



32 ledli dairesel  
animasyon sistemli  
32 leds circular  
animation system



50 adet reçete özelliği  
50 recipes features



Sesli uyan sistemi  
Audible caution  
system



Darbeye dayanıklı, su  
geçirmez, ön panel  
Impact resistant, waterproof,  
front panel



Çalışma voltajı  
(12VDC)  
Operating voltage  
(12VDC)

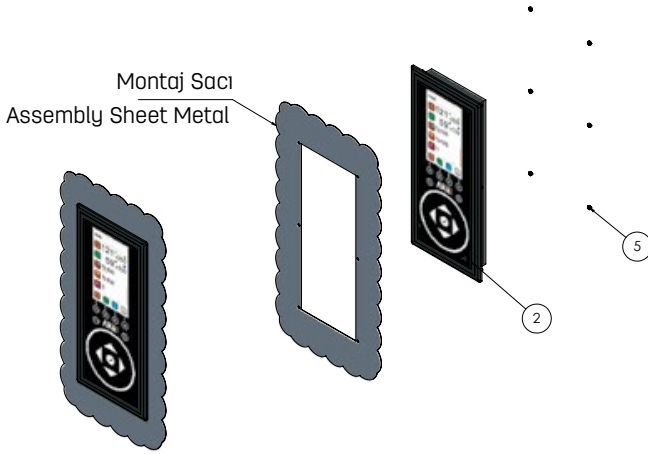
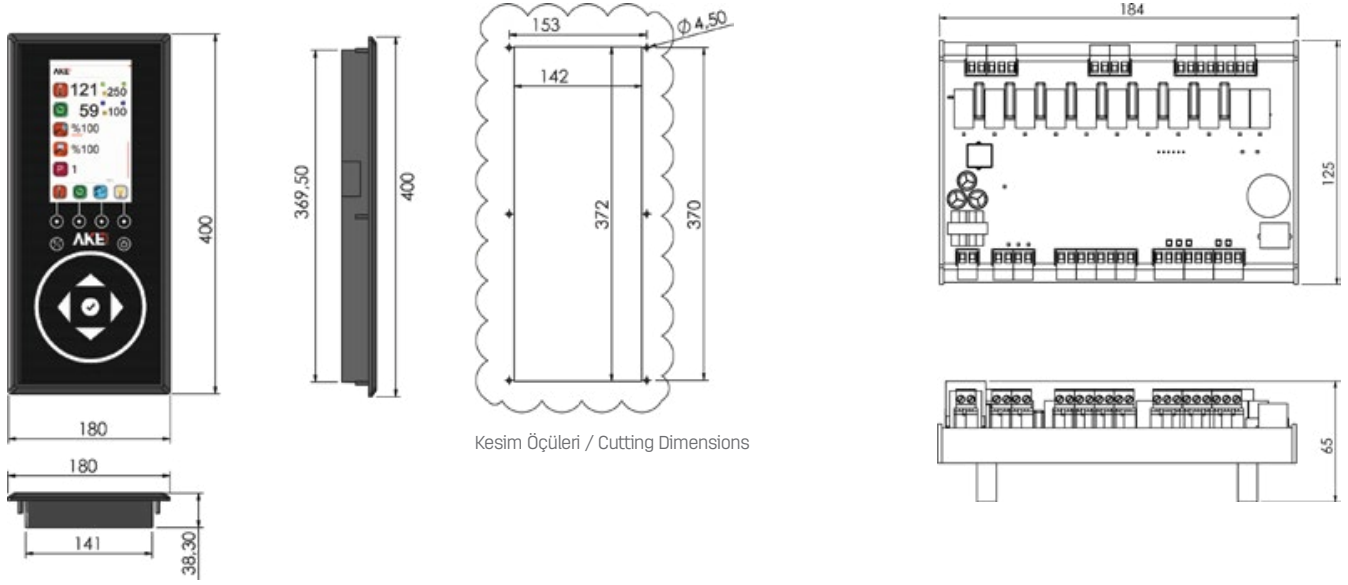

### Teknik Özellikler / Technical Specifications

- 7 inch, 480x800px çözünürlüklü, 16 milyon renkli TFT ekran
- 6 adet LED aydınlatmalı dokunmatik buton
- 5 adet dokunmatik buton
- 7 adet 220VAC çıkış (Max: 10A)
- 1 adet termokupl girişi
- 2 adet kuru kontak dijital giriş
- 1 adet brülör anza girişi (Gazlı Modelleri için)
- 7 inch, 480x800px resolution, 16 million color TFT screen
- 6 units of LED illuminated touch button
- 5 units of touch button
- 7 units of 220VAC output (Max: 10A)
- 1 unit of thermocouple input
- 2 units of digital input
- 1 unit burner fault input (For Gas Models)

### Örnek uygulama alanları Application

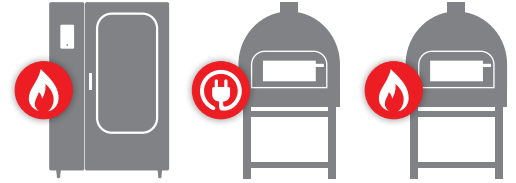

Ürün Kodu Product Code	Ürün İsmi Product Name
AKE.370.501.01.01	Elektrikli Döner Konveksiyonel Fırn Kontrol Ünitesi / Rotary Convection Oven Controller (Electrical)
AKE.370.501.01.02	Gazlı Döner Konveksiyonel Fırn Kontrol Ünitesi / Rotary Convection Oven Controller (Gas)
AKE.370.501.01.03	Elektrikli Konveksiyonel Fırn Kontrol Ünitesi / Convection Oven Controller (Electrical)
AKE.370.501.01.04	Gazlı Konveksiyonel Fırn Kontrol Ünitesi / Convection Oven Controller (Gas)
AKE.R012.01.01	Elektrikli Döner Konveksiyonel Fırn Röle Kartı / Rotary Convection Oven I/O Unit (Electrical)
AKE.R013.01.01	Gazlı Döner Konveksiyonel Fırn Röle Kartı / Rotary Convection Oven I/O Unit (Gas)
AKE.R014.01.01	Elektrikli Döner Konveksiyonel Fırn Röle Kartı / Rotary Convection Oven I/O Unit (Electrical)
AKE.R015.01.01	Gazlı Konveksiyonel Fırn Röle Kartı / Convection Oven I/O Unit (Gas)

Paket İçeriği  
Package Content

Montaj Aparatları  
Mounting Apparatus



Kullanma Kılavuzu  
User Manuals



Minimum Sipariş Miktarı  
Minimum Order quantity

12 Ad./Pcs

# AKE.370.502



7"  
İnç / Inch



64K Renkli TFT Ekran  
Color TFT Screen



Dokunmatik Buton  
Touch Button



# AKE.R016.01.01

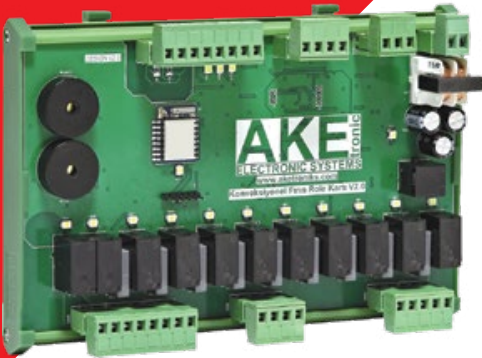

Zarif ve şık tasarımlı kontrol paneli  
Elegant and stylish control panel



Müşteriye özel tasarım  
Customer specific design

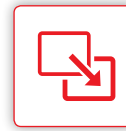

Değiştirilebilir görsel tasarım  
Changeable visual design



32 ledli dairesel animasyon sistemli  
32 leds circular animation system



50 adet reçete özelliği  
50 recipes features



Sesli uyan sistemi  
Audible caution system



Darbeye dayanıklı, su geçirmez, ön panel  
Impact resistant, waterproof, front panel



Çalışma voltajı  
(12VDC)  
Operating voltage  
(12VDC)

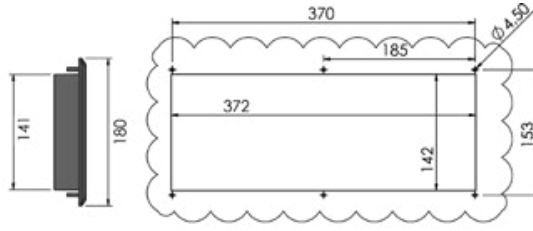
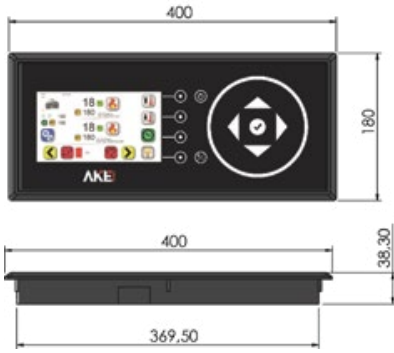

Kesim Ölçüleri / Cutting Dimensions

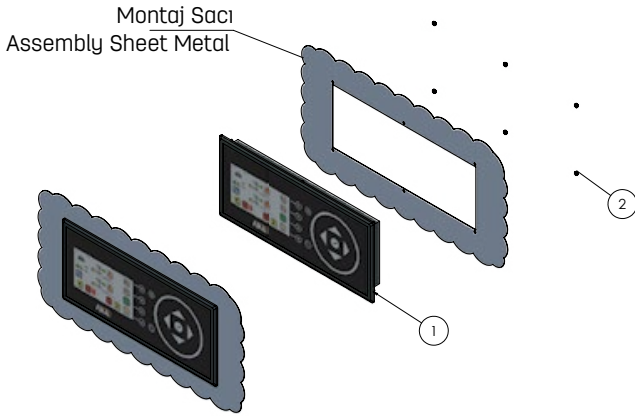
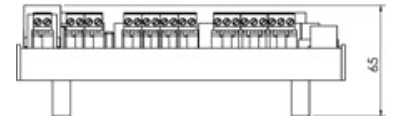
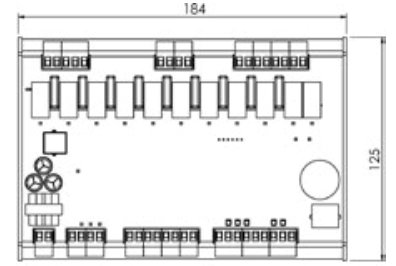

## Teknik Özellikler / Technical Specifications

- 7 inch, 480x800px çözünürlüklü, 16 milyon renkli TFT ekran
- 6 adet LED aydınlatmalı dokunmatik buton
- 5 adet dokunmatik buton
- 2 adet 220VAC çıkış (Max: 10A)
- 1 adet 0-10V analog çıkış (SSR için)
- 1 adet 0-10V analog çıkış (motor sürücü için)
- 2 adet transistör çıkışı (sürücü enable ve motor yön için)
- 2 adet termokupl girişi
- 1 adet brülör anıza girişi (Gazlı Modelleri için)
- 7 inch, 480x800px resolution, 16 million color TFT screen
- 6 units of LED illuminated touch button
- 5 units of touch button
- 2 units of 220VAC output (Max: 10A)
- 1 unit of 0-10V analog output (for SSR)
- 1 unit of 0-10V analog output (for motor drive)
- 2 units of transistor output (for drive enable and motor direction)
- 2 units of thermocouple input
- 1 unit burner fault input (For Gas Models)

Örnek uygulama alanları  
Application

Ürün Kodu Product Code	Ürün İsmi Product Name
AKE.370.502.01.01	Elektrikli Döner Tabanlı Fırın Kontrol Ünitesi / Rotating Pizza Oven Controller (Electrical)
AKE.370.502.01.02	Gazlı Döner Tabanlı Fırın Kontrol Ünitesi / Rotating Pizza Oven Controller (Gas)
AKE.370.502.01.03	Gazlı Sabit Tabanlı Fırın Kontrol Ünitesi / Pizza Oven Controller (Gas)
AKE.R016.01.01	Elektrikli Döner Tabanlı Fırın Röle Kartı / Rotating Pizza I/O Unit (Electrical)
AKE.R017.01.01	Gazlı Döner Tabanlı Fırın Röle Kartı / Rotating Pizza Oven I/O Unit (Gas)
AKE.R018.01.01	Gazlı Sabit Tabanlı Fırın Röle Kartı / Pizza Oven I/O Unit (Gas)

Paket İçeriği  
Package ContentMontaj Aparatları  
Mounting ApparatusKullanma Kılavuzu  
User ManualsMinimum Sipariş Miktarı  
Minimum Order quantity

12 Ad./Pcs

# AKE.207.013



7 Segment Ekran  
Segment Display



Dokunmatik Buton  
Touch Button



Zarif ve şık tasarımlı  
kontrol paneli  
Elegant and stylish  
control panel

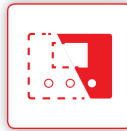

Müşteriye özel tasarım  
Customer specific  
design



Modbus haberleşme  
Modbus communication



Değiştirilebilir görsel  
tasarım  
Changeable visual  
design



Logo aydınlatması  
Logo illumination

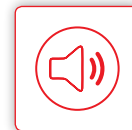

Sesli uyan sistemi  
Audible caution  
system



Darbeye dayanıklı, su  
geçirmez, ön panel  
Impact resistant, waterproof,  
front panel



Çalışma voltajı  
(24VAC)  
Operating voltage  
(24VAC)

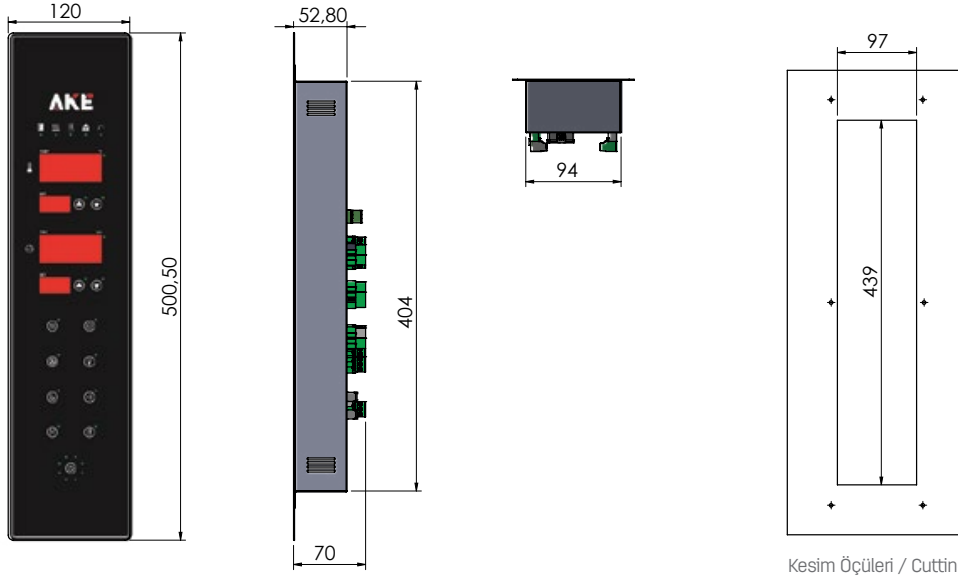

Kesim Ölçüleri / Cutting Dimensions

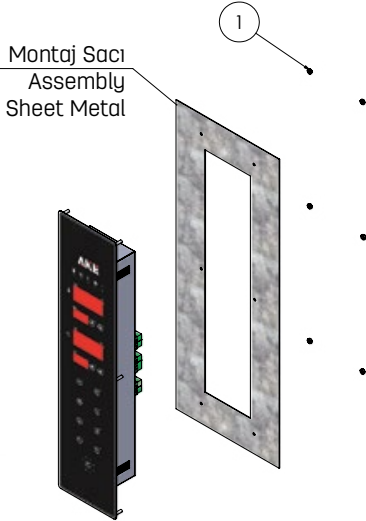

## Teknik Özellikler / Technical Specifications

- 4 adet 3 basamaklı 7 segment display
- 13 adet LED aydınlatmalı dokunmatik buton
- 8 adet ortak girişli röle çıkışı (Max: 220VAC-10A)
- 1 adet kuru kontak röle çıkışı (Max: 220VAC-16A)
- 2 adet termokupul girişi
- 1 adet PT100 veya PT1000 ısı probu girişi
- 4 adet izolasyonlu anıza girişi
- 4 adet kuru kontak dijital giriş
- 7 adet uyarı ikonu
- MODBUS haberleşme
- Logo aydınlatma
- Sesli uyarı sistemi
- 24 VAC çalışma voltajı
- 4 units of 3-stage 7 segment display
- 13 units of LED illuminated touch button
- 8 units of common input relay output (Max:220VAC-10A)
- 1 unit of contact output (Max:220VAC-10A)
- 2 units of thermocouple input
- 1 unit of PT100 or PT1000 probe input
- 4 units of insulated failure input
- 4 units of digital input
- 7 units of warning icon
- MODBUS communication
- Logo illumination
- Alarm buzzer
- 24VAC operating voltage

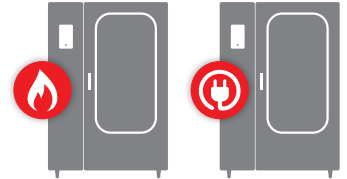
Örnek uygulama alanları  
Application

Ürün Kodu Product Code	Ürün İsmi Product Name
AKE.207013.01.01	Elektrikli Konveksiyonel Fırın Kontrol Ünitesi / Convection Oven Controller (Electrical)
AKE.207013.02.01	Gazlı Konveksiyonel Fırın Kontrol Ünitesi / Convection Oven Controller (Gas)
AKE.207013.03.01	Elektrikli Döner Konveksiyonel Fırın Kontrol Ünitesi / Rotary Convection Oven Controller (Electrical)
AKE.207013.04.01	Gazlı Döner Konveksiyonel Fırın Kontrol Ünitesi / Rotary Convection Oven Controller (Gas)

Paket İçeriği  
Package ContentMontaj Aparatları  
Mounting ApparatusKullanma Kılavuzu  
User ManualsMinimum Sipariş Miktarı  
Minimum Order quantity

12 Ad./Pcs

# AKE.343.502



4,3"  
İnç / Inch



64K Renkli TFT Ekran  
Color TFT Screen



Dokunmatik Buton  
Touch Button



# AKE.R008.01.01

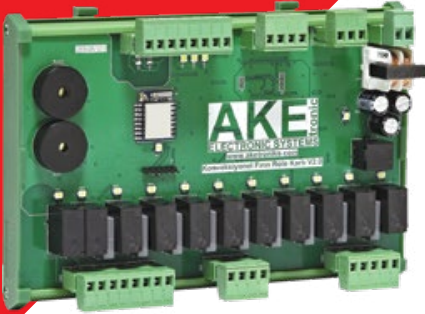

Zarif ve şık tasarımlı kontrol paneli  
Elegant and stylish control panel

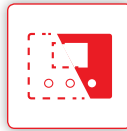

Müşteriye özel tasarım  
Customer specific design

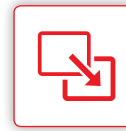

Değiştirilebilir görsel tasarım  
Changeable visual design



99 adet reçete özelliği  
99 recipes features



Sesli uyan sistemi  
Audible caution system



Çalışma voltajı (12VDC)  
Operating voltage (12VDC)

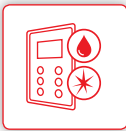

Darbeye dayanıklı, su geçirmez, ön panel  
Impact resistant, waterproof, front panel

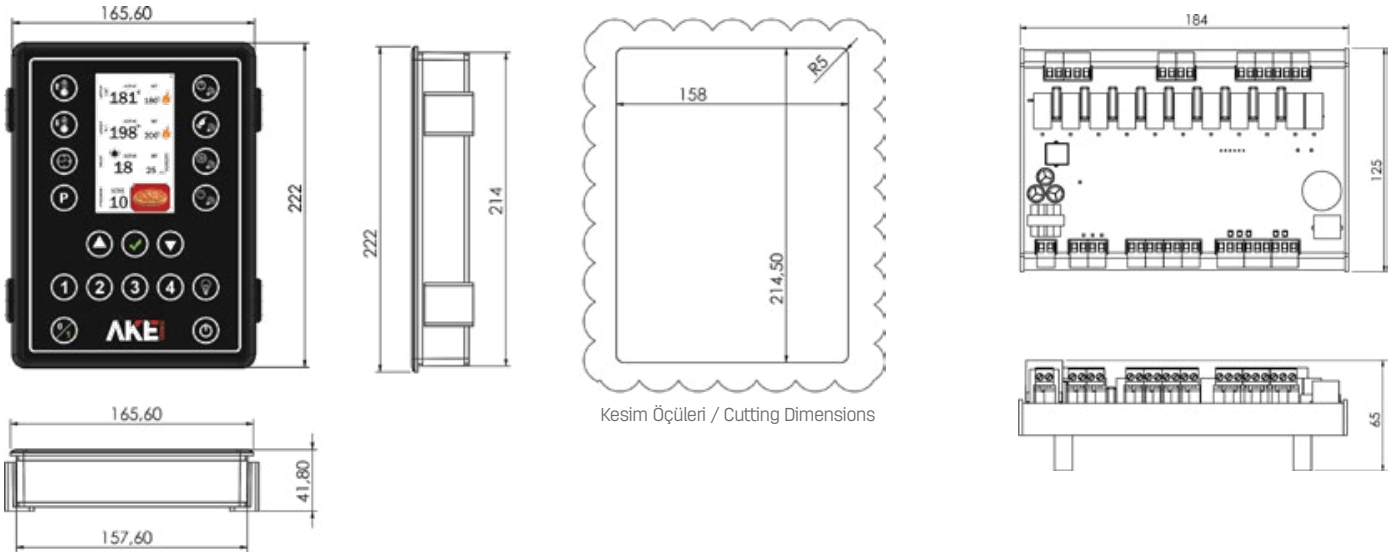

Kesim Ölçüleri / Cutting Dimensions

## Teknik Özellikler / Technical Specifications

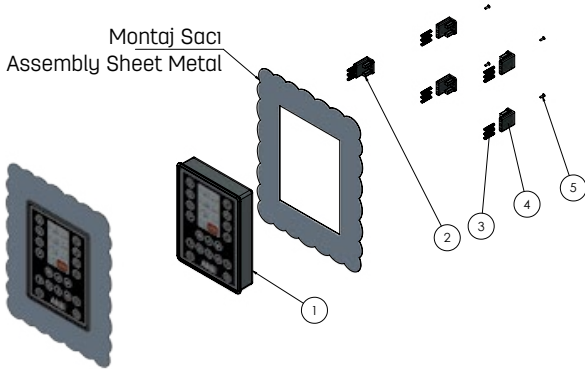

- 4,3 inch, 480x272px çözünürlüklü, 16 milyon renkli TFT ekran
- 18 adet LED aydınlatmalı dokunmatik buton
- 6 adet 220VAC çıkış (Max: 10A)
- 2 adet termokupul girişi
- 1 adet kuru kontak dijital giriş
- 4,3 inch, 480x272px resolution, 16 million color TFT screen
- 18 units of LED illuminated touch button
- 6 units of 220VAC output(Max: 10A)
- 2 units of thermocouple input
- 1 unit of digital input

## Örnek uygulama alanları Application

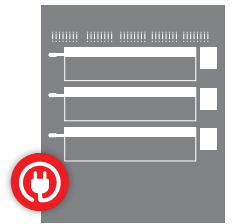

Ürün Kodu Product Code	Ürün İsmi Product Name
AKE.343.502.01.01	Elektrikli Taş Tabanlı Fırın Kontrol Ünitesi / Deck Oven Controller (Electrical)
AKE.R008.01.01	Elektrikli Taş Tabanlı Fırın Röle Kartı / Deck Oven I/O Unit (Electrical)

Paket İçeriği  
Package Content

Montaj Aparatları  
Mounting Apparatus



Kullanma Kılavuzu  
User Manuals



Minimum Sipariş Miktarı  
Minimum Order quantity

12 Ad./Pcs

# AKE.207.014



7 Segment Ekran  
Segment Display



Dokunmatik Buton  
Touch Button



Zarif ve şık tasarımlı kontrol paneli  
Elegant and stylish control panel

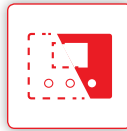

Müşteriye özel tasarım  
Customer specific design

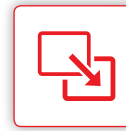

Değiştirilebilir görsel tasarım  
Changeable visual design



Çalışma voltajı (24VAC)  
Operating voltage (24VAC)



Sesli uyan sistemi  
Audible caution system



Logo aydınlatması  
Logo illumination



Darbeye dayanıklı, su geçirmez, ön panel  
Impact resistant, waterproof, front panel



Modbus haberleşme  
Modbus communication

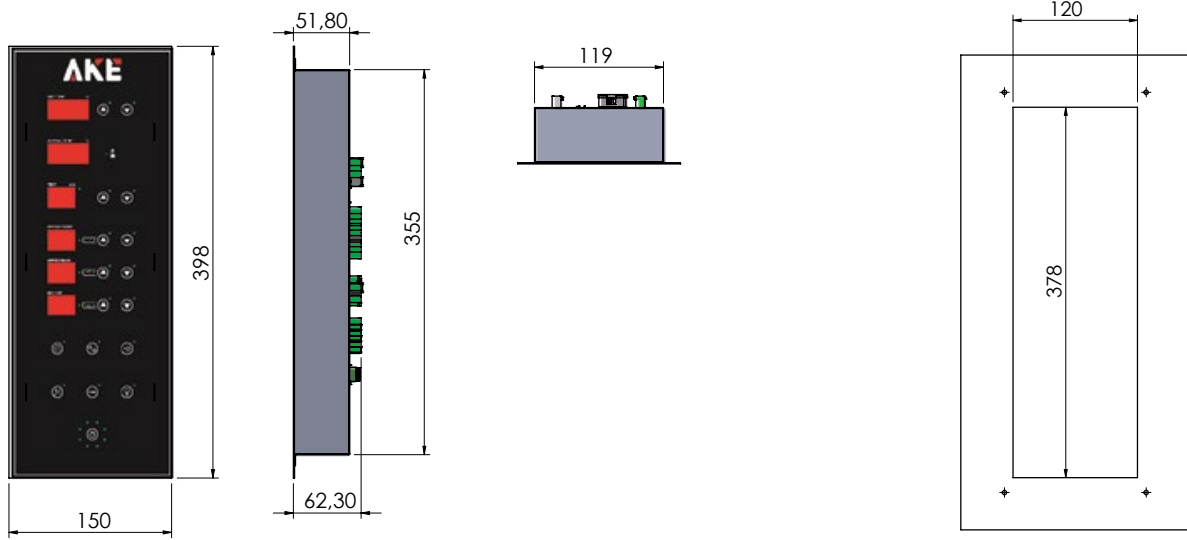

Kesim Ölçüleri / Cutting Dimensions

## Teknik Özellikler / Technical Specifications

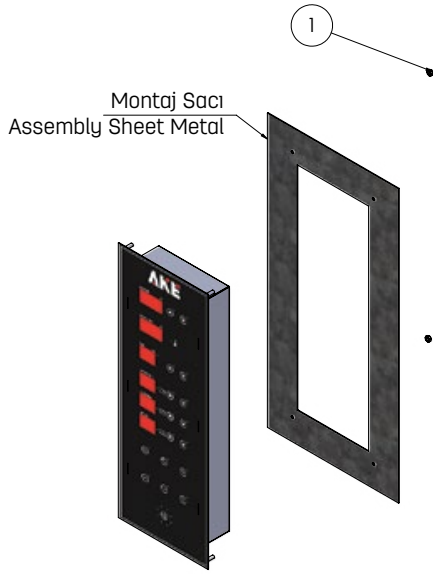

- 2 adet 3 basamaklı 7 segment display
- 4 adet 2 basamaklı 7 segment display
- 17 adet LED aydınlatmalı dokunmatik buton
- 8 adet ortak girişli röle çıkışı (Max: 220VAC-10A)
- 1 adet kuru kontak röle çıkışı (Max: 220VAC-16A)
- 2 adet termokupul girişi
- 1 adet PT100 veya PT1000 ısı probu girişi
- 4 adet izolasyonlu anza girişi
- 4 adet kuru kontak dijital giriş
- 5 adet uyan ikonu
- MODBUS haberleşme
- Logo aydınlatma
- Sesli uyan sistemi
- 24 VAC çalışma voltajı
- 2 units of 3-stage 7 segment display
- 4 units of 2-stage 7 segment display
- 17 units of LED illuminated touch button
- 8 units of common input relay output (Max:220VAC-10A)
- 1 unit of contact output (Max:220VAC-16A)
- 2 units of thermocouple input
- 1 unit of PT100 or PT1000 probe input
- 4 units of insulated failure input
- 4 units of digital input
- 5 units of warning icon
- MODBUS communication
- Logo illumination
- Alarm buzzer
- 24VAC operating voltage

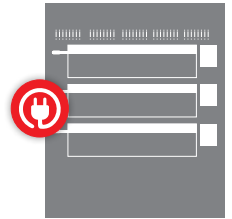
Örnek uygulama alanları  
Application

Ürün Kodu Product Code	Ürün İsmi Product Name
AKE.207014.01.01	Elektrikli Taş Tabanlı Fırın Kontrol Ünitesi / Deck Oven Controller (Electrical)

Paket İçeriği  
Package ContentMontaj Aparatları  
Mounting ApparatusKullanma Kılavuzu  
User ManualsMinimum Sipariş Miktarı  
Minimum Order quantity

12 Ad./Pcs

# AKE.207.015



7 Segment Ekran  
Segment Display



Dokunmatik Buton  
Touch Button



Zarif ve şık tasarımlı  
kontrol paneli  
Elegant and stylish  
control panel



Müşteriye özel tasarım  
Customer specific  
design



99 adet reçete  
özellği  
99 recipes features



Çalışma voltajı  
(24VAC)  
Operating voltage  
(24VAC)



Sesli uyan sistemi  
Audible caution  
system



Değiştirilebilir görsel  
tasarım  
Changeable visual  
design

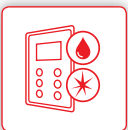

Darbeye dayanıklı, su  
geçirmez, ön panel  
Impact resistant, waterproof,  
front panel



Modbus haberleşme  
Modbus communication



Logo aydınlatması  
Logo illumination

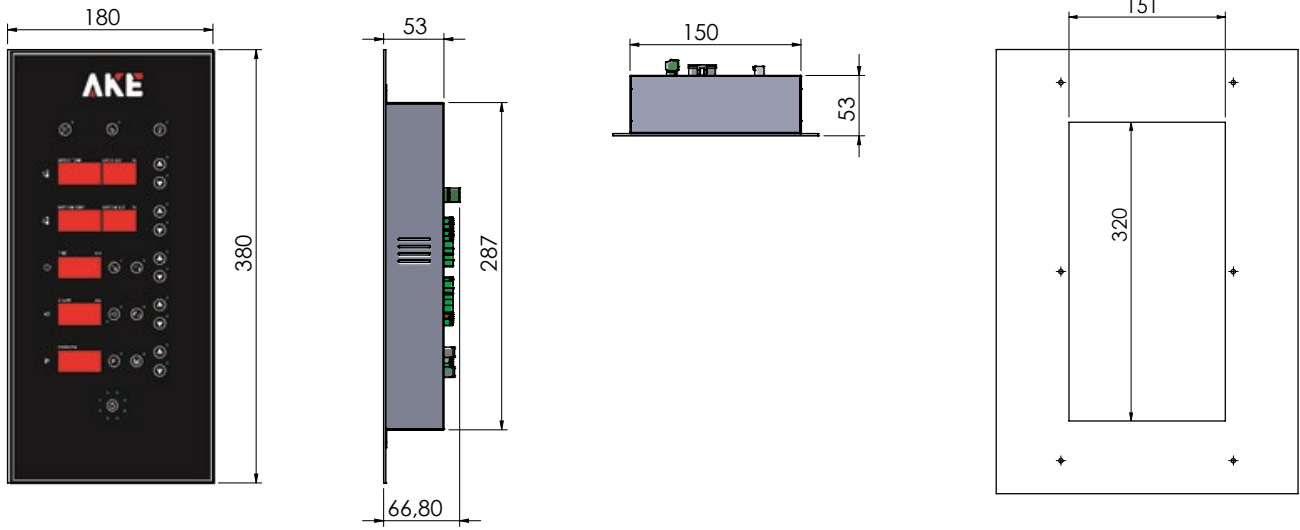

Kesim Ölçüleri / Cutting Dimensions

## Teknik Özellikler / Technical Specifications

- 7 adet 3 basamaklı 7 segment display
- 20 adet LED aydınlatmalı dokunmatik buton
- 7 adet ortak girişli röle çıkışı (Max: 220VAC-10A)
- 2 adet termokupul girişi
- 4 adet izolasyonlu anza girişi
- 4 adet kuru kontak dijital giriş
- MODBUS haberleşme
- 99 adet reçete özelliği
- Sesli uyan sistemi
- 24 VAC çalışma voltajı
- 7 units of 3-stage 7 segment display
- 20 units of LED illuminated touch button
- 7 units of common input relay output (Max:220VAC-10A)
- 2 units of thermocouple input
- 4 units of insulated failure input
- 4 units of digital input
- MODBUS communication
- 99 recipes features
- Logo illumination
- Alarm buzzer
- 24VAC operating voltage

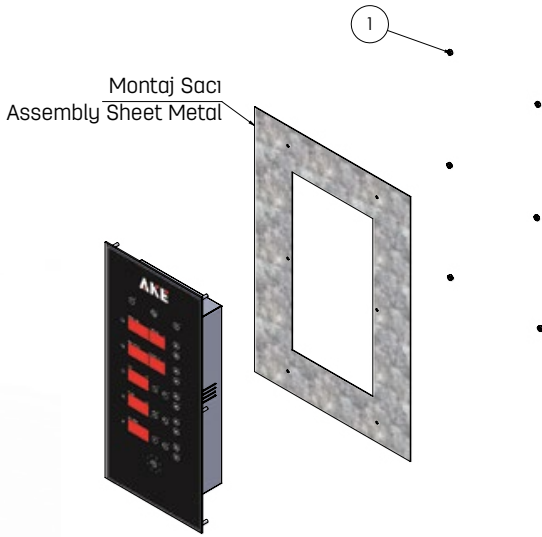

## Örnek uygulama alanları Application

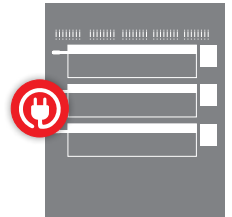

Ürün Kodu Product Code	Ürün İsmi Product Name
---------------------------	---------------------------

AKE.207015.01.01 Elektrikli Taş Tabanlı Fırın Kontrol Ünitesi / Deck Oven Controller (Electrical)

**Paket İçeriği**  
Package Content

Montaj Aparatları  
Mounting Apparatus ✓

Kullanma Kılavuzu  
User Manuals ✓

Minimum Sipariş Miktarı  
Minimum Order quantity

12 Ad./Pcs

# AKE.324.002



2.4"  
İnç / Inch



64K Renkli TFT Ekran  
Color TFT Screen



Dokunmatik Buton  
Touch Button

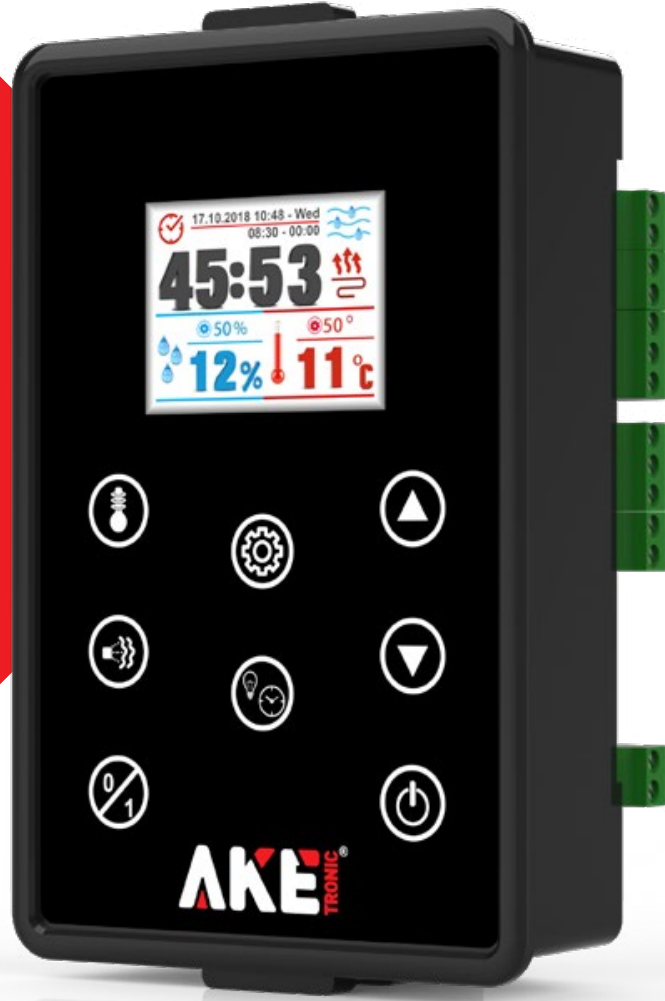

## AKE.HTS.01



Zarif ve şık tasarımlı kontrol paneli  
Elegant and stylish control panel

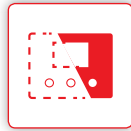

Müşteriye özel tasarım  
Customer specific design

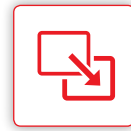

Değiştirilebilir görsel tasarım  
Changeable visual design

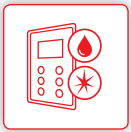

Darbeye dayanıklı, su geçirmez, ön panel  
Impact resistant, waterproof, front panel



Sesli uyan sistemi  
Audible caution system



Uyan aydınlatmaları  
Warning lights



Esnek çalışma voltajı (85-305VAC)  
Flexible operating voltage (85-305VAC)



Sensör Girişi  
Sensor Input

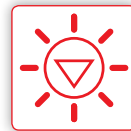

LED Aydınlatmalı dokunmatik buton  
LED illuminated touch button

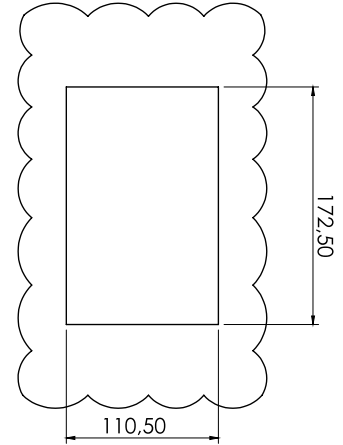
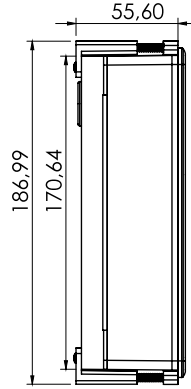
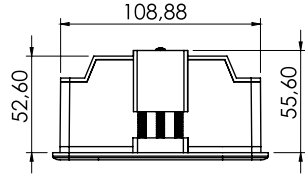
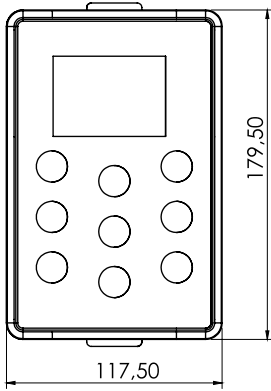

Kesim Ölçüleri / Cutting Dimensions

Kesim Ölçüleri / Cutting Dimensions

## Teknik Özellikler / Technical Specifications

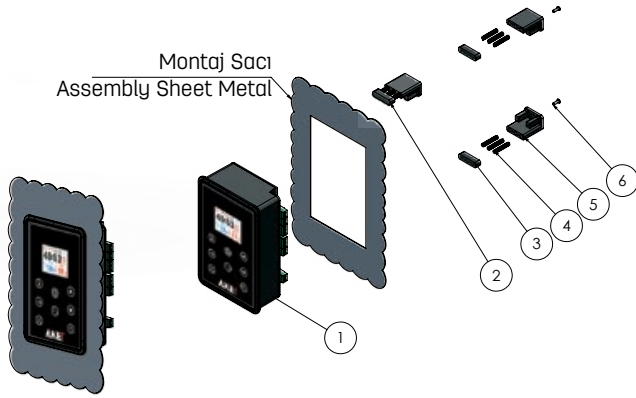

- 2.4" TFT ekran
  - 9 adet LED aydınlatmalı dokunmatik buton
  - 4+4 adet ortak girişli röle çıkışı
  - 6 adet kuru kontak dijital giriş
  - 2 adet 4-20 mA analog giriş (Nem ve sıcaklık sensörü için.)
  - 1 adet termokupul girişi
  - 3 adet kuru kontak dijital çıkış
  - 3 adet 0-10V analog çıkış veya NTC girişi
- 2.4" TFT screen
  - 9 Units of LED illuminated touch buttons
  - 4+4 Units of relay outputs
  - 6 Units of contact inputs
  - 2 units of 4-20mA analog input (For humidity and temperature sensor.)
  - 1 units of thermocouple input
  - 3 units of digital output
  - 3 units of 0-10V analog output or NTC input

## Örnek uygulama alanları Application



Ürün Kodu Product Code	Ürün İsmi Product Name
AKE.324.001.06.01	Mayalandırma Makinesi Kontrol Ünitesi / Proofer Controller
AKE.HTS.01	Sıcaklık ve Nem Sensörü / Heat and Humidity Sensor

Paket İçeriği  
Package Content

Montaj Aparatları  
Mounting Apparatus



Kullanma Kılavuzu  
User Manuals



Minimum Sipariş Miktarı  
Minimum Order quantity

12 Ad./Pcs

# AKE.207.016



7 Segment Ekran  
Segment Display



Dokunmatik Buton  
Touch Button



## AKE.HTS.01



Zarif ve şık tasarımlı kontrol paneli  
Elegant and stylish control panel



Müşteriye özel tasarım  
Customer specific design

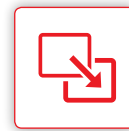

Değiştirilebilir görsel tasarım  
Changeable visual design

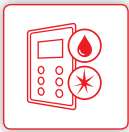

Darbeye dayanıklı, su geçirmez, ön panel  
Impact resistant, waterproof, front panel



Sesli uyan sistemi  
Audible caution system



Modbus haberleşme  
Modbus communication



Çalışma voltajı  
(24VAC)  
Operating voltage  
(24VAC)



Sensör Girişi  
Sensor Input

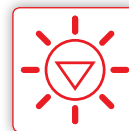

LED Aydınlatmalı dokunmatik buton  
LED illuminated touch button



### Teknik Özellikler / Technical Specifications

- 2 adet 3 basamaklı 7 segment display
- 8 adet LED aydınlatmalı dokunmatik buton
- 7 adet ortak girişli röle çıkışı (Max: 220VAC-10A)
- 2 adet termokupul girişi
- 4 adet izolasyonlu anza girişi
- 4 adet kuru kontak dijital giriş
- 2 adet 4-20mA analog giriş (Nem ve sıcaklık sensörü için)
- MODBUS haberleşme
- Sesli uyan sistemi
- 24 VAC çalışma voltajı
- 2 units of 3-stage 7 segment display
- 8 units of LED illuminated touch button
- 7 units of common input relay output (Max:220VAC-10A)
- 2 units of thermocouple input
- 4 units of insulated failure input
- 4 units of digital input
- 2 units of 4-20mA analog input (For humidity and temperature sensor)
- MODBUS communication
- Alarm buzzer
- 24VAC operating vantage

### Örnek uygulama alanları Application



Ürün Kodu  
Product Code

Ürün İsmi  
Product Name

AKE.207016.01.01

Mayalandırma Makinesi Kontrol Ünitesi / Proofer Controller  
(Nem ve Sıcaklık sensörü fiyata dahildir / Quotation is including humidity and temperature sensor)

Paket İçeriği  
Package Content

Montaj Aparatları  
Mounting Apparatus



Kullanma Kılavuzu  
User Manuals



Minimum Sipariş Miktarı  
Minimum Order quantity

12 Ad./Pcs



2,4" 3 Adet  
İnç / Inch  
3 Unit



64K Renkli TFT Ekran  
Color TFT Screen



Dokunmatik Buton  
Touch Button

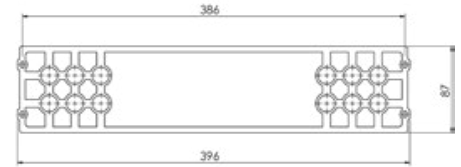
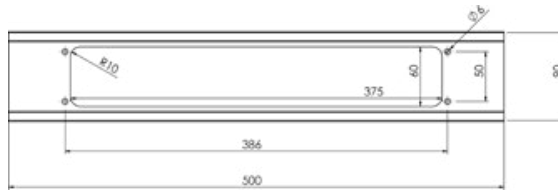

Zarif ve şık tasarımlı kontrol paneli  
Elegant and stylish control panel



Müşteriye özel tasarım  
Customer specific design



Etiket ve kutu görsel amaçlıdır.  
Paket içeriğinde yer almamaktadır.  
The label and box are for visual purposes.  
Not included in the package content.



Darbeye dayanıklı, su geçirmez, ön panel  
Impact resistant, waterproof, front panel



Esnek çalışma voltajı (85-305VAC)  
Flexible operating voltage (85-305VAC)



Değiştirilebilir görsel tasarım  
Changeable visual design



Sesli uyan sistemi  
Audible caution system

## Teknik Özellikler / Technical Specifications

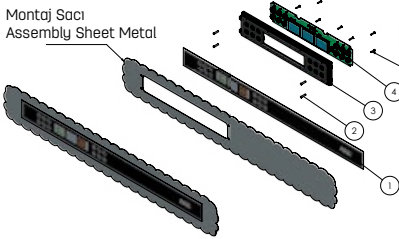

- 3 adet 2,4 inch, 320x240px çözünürlüklü, 16 milyon renkli TFT ekran
- 12 adet LED aydınlatmalı dokunmatik buton
- 1 adet kuru kontak röle çıkışı (Max: 220VAC-30A)
- 3 adet ortak girişli röle çıkışı (Max: 220VAC-5A)
- 1 adet 0-10V analog çıkış/giriş
- Kompakt tek faz motor kontrol (Aşın Akım Koruması, Motor Hız Kontrol, Motor Freni, Motor Yön Kontrolü)
- 1 adet kuru kontak dijital giriş
- 1 adet termokupl girişi
- 3 units of 2,4 inch, 320x240px resolution, 16 million color TFT screen
- 12 units of LED illuminated touch button
- 1 unit of dry contact relay output (Max: 220VAC-30A)
- 3 units of common input relay output (Max: 220VAC-5A)
- 1 unit of 0-10V analog output/input
- Compact single-phase motor control (Overcurrent Protection, Motor Speed Control, Motor Brake, Motor Direction Control)
- 1 unit of digital input
- 1 unit of thermocouple input

## Örnek uygulama alanları Application

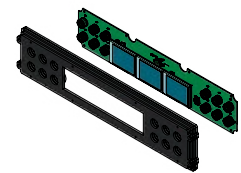

Ürün Kodu  
Product Code

AKE.324.005.01.01

Ürün İsmi  
Product Name

Elektrikli Konveksiyonel Fınn Kontrol Ünitesi  
Convection Oven Controller (Electrical)

Paket İçeriği  
Package Content

Montaj Aparatları  
Mounting Apparatus ✓

Kullanma Kılavuzu  
User Manuals ✓

Kutu ve Etiket Dahil Değildir  
Box and Label Not Included ✗

Minimum Sipariş Miktarı  
Minimum Order Quantity 12 Ad./Pcs



2,4"  
inç / Inch



64K Renkli TFT Ekran  
Color TFT Screen



Dokunmatik Buton  
Touch Button



Etiket ve kutu görsel amaçlıdır.  
Paket içeriğinde yer almamaktadır.  
The label and box are for visual purposes.  
Not included in the package content.

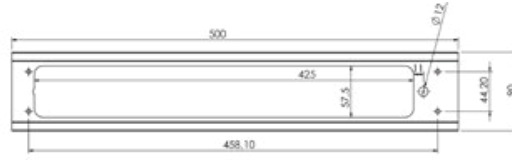
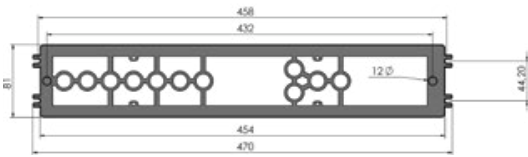

Zarif ve şık tasarımı  
kontrol paneli  
Elegant and stylish  
control panel



Müşteriye özel tasarım  
Customer specific  
design



Değiştirilebilir görsel  
tasarım  
Changeable visual  
design



Sesli uyarı  
sistemi  
Audible caution  
system



99 adet reçete özelliği  
99 recipes features



Darbeye dayanıklı, su  
geçirmez, ön panel  
Impact resistant,  
waterproof, front panel



Çalışma voltajı  
(220-240VAC)  
Operating voltage  
(220-240VAC)

Montaj Sacı  
Assembly Sheet Metal

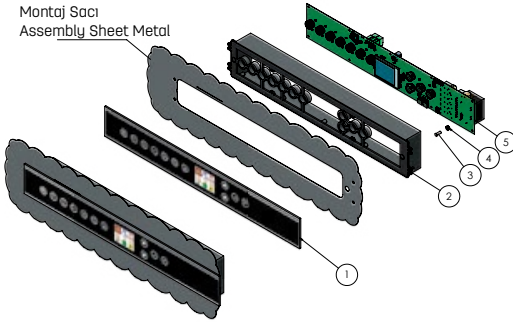

## Teknik Özellikler / Technical Specifications

- 2,4 inç, 320x240px çözünürlüklü, 16 milyon renkli TFT ekran
- 11 adet LED aydınlatmalı dokunmatik buton
- 5 adet 220VAC çıkış (Max: 10A)
- 1 adet kuru kontak dijital giriş
- 1 adet termokupl girişi
- 2,4 inch, 320x240px resolution, 16 million color TFT screen
- 11 unit of LED illuminated touch button
- 5 units of 220VAC output(Max: 10A)
- 1 unit of digital input
- 1 unit of thermocouple input

## Örnek uygulama alanları Application

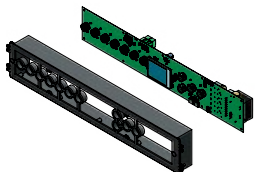

Ürün Kodu  
Product Code

AKE.324.006.01.01

Ürün İsmi  
Product Name

Elektrikli Konveksiyonel Fırın Kontrol Ünitesi  
Convection Oven Controller (Electrical)

Paket İçeriği  
Package Content

Montaj Aparatları  
Mounting Apparatus ✓

Kullanma Kılavuzu  
User Manuals ✓

Kutu ve Etiket Dahil Değildir  
Box and Label Not Included ✗

Minimum Sipariş Miktarı  
Minimum Order Quantity 12 Ad./Pcs



7 Segment Ekran  
Segment Display



Dokunmatik Buton  
Touch Button

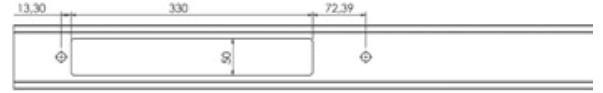

Zarif ve şık tasarımlı kontrol paneli  
Elegant and stylish control panel



Müşteriye özel tasarım  
Customer specific design



Etiket ve kutu görsel amaçlıdır.  
Paket içeriğinde yer almamaktadır.  
The label and box are for visual purposes.  
Not included in the package content.



Darbeye dayanıklı, su geçirmez, ön panel  
Impact resistant, waterproof, front panel

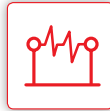

Çalışma voltajı (220-240VAC)  
Operating voltage (220-240VAC)



Değiştirilebilir görsel tasarım  
Changeable visual design



Sesli uyan sistemi  
Audible caution system

Montaj Sacı  
Assembly Sheet Metal

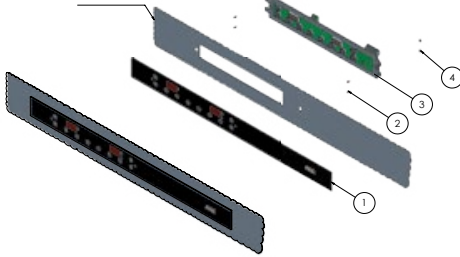

## Teknik Özellikler / Technical Specifications

- 2 adet 3 basamaklı 7 segment display
- 10 adet LED aydınlatmalı dokunmatik buton
- 5 adet 220VAC çıkış (Max: 10A)
- 1 adet kuru kontak dijital giriş
- 1 adet termokupl girişi
- 2 units of 3-stage 7 segment display
- 10 units of LED illuminated touch button
- 5 units of 220VAC output (Max: 10A)
- 1 unit of digital input
- 1 unit of thermocouple input

## Örnek uygulama alanları Application

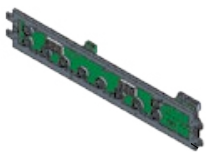
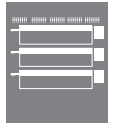

Ürün Kodu  
Product Code

AKE.207.006.01.01

Ürün İsmi  
Product Name

Elektrikli Konveksiyonel Fırn Kontrol Ünitesi  
Convection Oven Controller (Electrical)

Paket İçeriği  
Package Content

Montaj Aparatları  
Mounting Apparatus ✓

Kullanma Kılavuzu  
User Manuals ✓

Kutu ve Etiket Dahil Değildir  
Box and Label Not Included ✗

Minimum Sipariş Miktarı  
Minimum Order Quantity

12 Ad./Pcs



7 Segment Ekran  
Segment Display



Dokunmatik Buton  
Touch Button

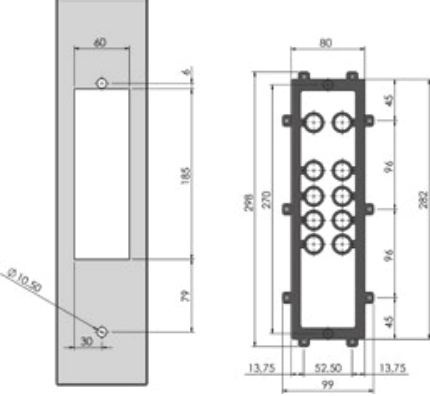

Müşteriye özel tasarım  
Customer specific design



Değiştirilebilir görsel tasarım  
Changeable visual design



Etiket ve kutu görsel amaçlıdır.  
Paket içeriğinde yer almamaktadır.  
The label and box are for visual purposes.  
Not included in the package content.



Darbeye dayanıklı, su geçirmez, ön panel  
Impact resistant, waterproof, front panel



Çalışma voltajı (220-240VAC)  
Operating voltage (220-240VAC)



Zarif ve şık tasarımlı kontrol paneli  
Elegant and stylish control panel



Sesli uyarı sistemi  
Audible caution system

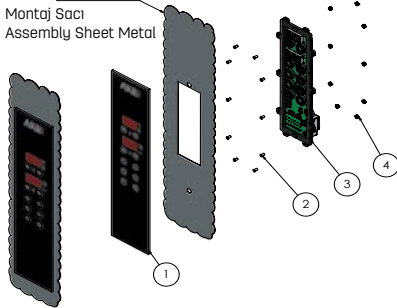

## Teknik Özellikler / Technical Specifications

- 2 adet 3 basamaklı 7 segment display
- 10 adet LED aydınlatmalı dokunmatik buton
- 6 adet 220VAC çıkış (Max: 5A)
- 1 adet kuru kontak dijital giriş
- 1 adet termokupl girişi
- 2 units of 3-stage 7 segment display
- 10 units of LED illuminated touch button
- 6 units of 220VAC output (Max: 5A)
- 1 unit of digital input
- 1 unit of thermocouple input

## Örnek uygulama alanları Application

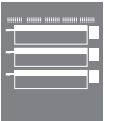

Ürün Kodu  
Product Code

AKE.20700701.01

Ürün İsmi  
Product Name

Elektrikli Konveksiyonel Fırın Kontrol Ünitesi  
Convection Oven Controller (Electrical)

Paket İçeriği  
Package Content

Montaj Aparatları  
Mounting Apparatus ✓

Kullanma Kılavuzu  
User Manuals ✓

Kutu ve Etiket Dahil Değildir  
Box and Label Not Included ✗

Minimum Sipariş Miktarı  
Minimum Order Quantity 12 Ad./Pcs



7 Segment Ekran  
Segment Display



Dokunmatik Buton  
Touch Button

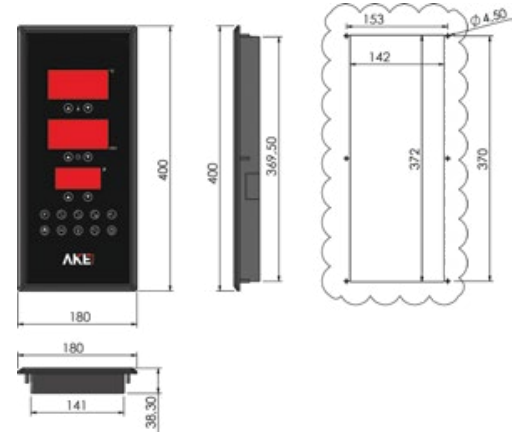

Zarif ve şık tasarımlı kontrol paneli  
Elegant and stylish control panel



Müşteriye özel tasarım  
Customer specific design

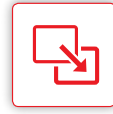

Değiştirilebilir görsel tasarım  
Changeable visual design



Sesli uyarı sistemi  
Audible caution system



Darbeye dayanıklı, su geçirmez, ön panel  
Impact resistant, waterproof, front panel



Esnek çalışma voltajı (12-24VAC)  
Flexible operating voltage (12-24VAC)



99 adet reçete özelliği  
99 recipes features

Montaj Sacı  
Assembly Sheet Metal

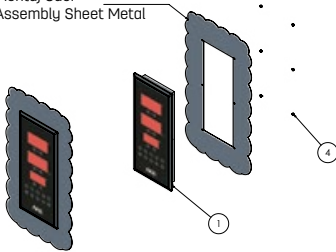

## Teknik Özellikler / Technical Specifications

- 3 adet 3 basamaklı ultra büyük 7 segment display
- 16 adet LED aydınlatmalı dokunmatik buton
- 13 adet ortak girişli röle çıkışı (Max: 220VAC-5A)
- 4 adet kuru kontak dijital giriş
- 4 adet termokupl giriş
- 2 adet brülör anıza girişi
- 3 units of 3-stage ultra size 7 segment display
- 16 units of LED illuminated touch button
- 13 units of common input relay output (Max: 220VAC-5A)
- 4 units of digital input
- 4 units of thermocouple input
- 2 units of burner failure input

## Örnek uygulama alanları Application

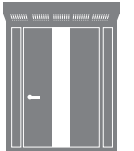

Ürün Kodu Product Code	Ürün İsmi Product Name
---------------------------	---------------------------

AKE.207008.01.01 Döner Ekmek Fırını Kontrol Ünitesi / Rotary Oven Controller

Paket İçeriği  
Package Content

Montaj Aparatları  
Mounting Apparatus



Kullanma Kılavuzu  
User Manuals



Minimum Sipariş Miktarı  
Minimum Order quantity

12 Ad./Pcs

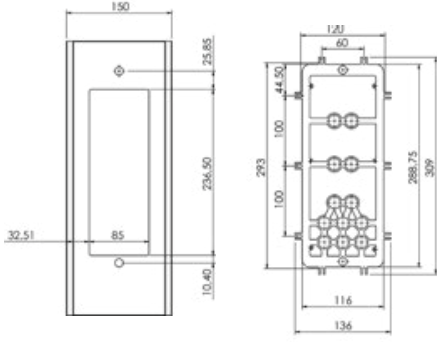

7 Segment Ekran  
Segment Display



Dokunmatik Buton  
Touch Button



Etiket ve kutu görsel amaçlıdır.  
Paket içeriğinde yer almamaktadır.  
The label and box are for visual purposes.  
Not included in the package content.



Zarif ve şık tasarımı kontrol paneli  
Elegant and stylish control panel



Müşteriye özel tasarım  
Customer specific design



Değiştirilebilir görsel tasarım  
Changeable visual design



Sesli uyarı sistemi  
Audible caution system



Darbeye dayanıklı, su geçirmez, ön panel  
Impact resistant, waterproof, front panel



Esnek çalışma voltajı (85-305VAC)  
Flexible operating voltage (85-305VAC)



99 adet reçete özelliği  
99 recipes features

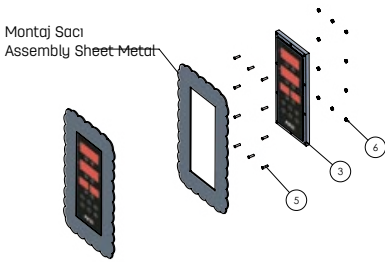

## Teknik Özellikler / Technical Specifications

- 2 adet 3 basamaklı büyük 7 segment display
- 2 adet 2 basamaklı 7 segment display
- 12 adet LED aydınlatmalı dokunmatik buton
- 1 adet kuru kontak röle çıkışı (Max: 220VAC-10A)
- 6 adet ortak girişli röle çıkışı (Max: 220VAC-10A)
- 1 adet kuru kontak dijital giriş
- 2 adet termokupl girişi
- 1 adet brülör anıza girişi
- 2 units of 3 large digits 7 segment display
- 2 units of 2 digits 7 segment display
- 12 units of LED illuminated touch button
- 1 unit of dry contact relay output (Max: 220VAC-10A)
- 6 units of common input relay output (Max: 220VAC-10A)
- 1 unit of digital input
- 2 units of thermocouple input
- 1 unit of burner failure input

## Örnek uygulama alanları Application



Ürün Kodu  
Product Code

Ürün İsmi  
Product Name

AKE.207009.01.01 Pizza Fırını Kontrol Ünitesi / Pizza Oven Controller

Paket İçeriği  
Package Content

Montaj Aparatları  
Mounting Apparatus ✓

Kullanma Kılavuzu  
User Manuals ✓

Kutu ve Etiket Dahil Değildir  
Box and Label Not Included ✗

Minimum Sipariş Miktarı  
Minimum Order Quantity 12 Ad./Pcs



7 2 Adet Segment Ekran  
2 Units Segment Display



Dokunmatik Buton  
Touch Button

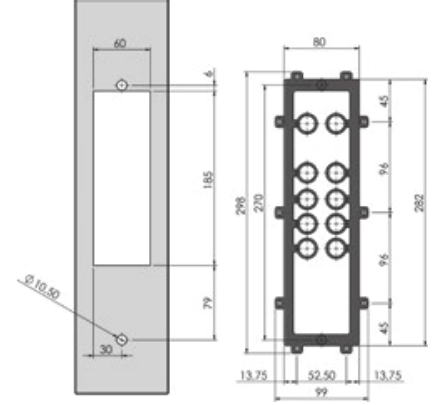
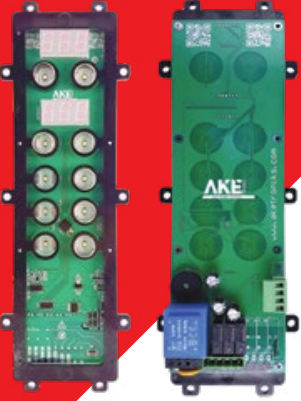

Zarif ve şık tasarımlı kontrol paneli  
Elegant and stylish control panel



Müşteriye özel tasarım  
Customer specific design



Etiket ve kutu görsel amaçlıdır.  
Paket içeriğinde yer almamaktadır.  
The label and box are for visual purposes.  
Not included in the package content.



Darbeye dayanıklı, su geçirmez, ön panel  
Impact resistant, waterproof, front panel



Çalışma voltajı (220-240VAC)  
Operating voltage (220-240VAC)



Değiştirilebilir görsel tasarım  
Changeable visual design



Sesli uyan sistemi  
Audible caution system

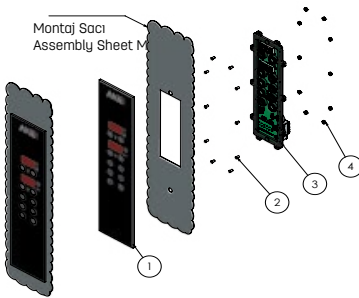

## Teknik Özellikler / Technical Specifications

- 2 adet 3 basamaklı 7 segment display
- 7 adet LED aydınlatmalı dokunmatik buton
- 3 adet 220VAC çıkış (Max: 5A)
- 2 adet termokupl girişi
- 2 units of 3 large digits 7 segment display
- 7 units of LED illuminated touch button
- 3 units of 220VAC output (Max: 5A)
- 2 units of thermocouple input

## Örnek uygulama alanları Application



Ürün Kodu  
Product Code

AKE.207.010.01.01

Ürün İsmi  
Product Name

Pizza Fırını Kontrol Ünitesi / Pizza Oven Controller

Paket İçeriği  
Package Content

Montaj Aparatları  
Mounting Apparatus ✓

Kullanma Kılavuzu  
User Manuals ✓

Kutu ve Etiket Dahil Değildir  
Box and Label Not Included ✗

Minimum Sipariş Miktarı  
Minimum Order Quantity 12 Ad./Pcs



## Hazırlık Grubu Kontrol Üniteleri Controllers For Preparation

Mikser Kontrol Üniteleri  
Planetary Mixer Controller

Hamur Yoğurma Makineleri Kontrol Üniteleri  
Dough Mixer Controllers

Patates Soyma Makineleri Kontrol Üniteleri  
Potato Peelers Controllers

Kestart Makineleri Kontrol Üniteleri  
Volumetric Dough Dividers

Ara Dinlendirme Makineleri Kontrol Üniteleri  
Dough Proofing Machines Controllers



# AKE.343.501



4.3"  
İnç / Inch



64K Renkli TFT Ekran  
Color TFT Screen



Dokunmatik Buton  
Touch Button



## AKE.R001.01.01



Zarif ve şık tasarımlı kontrol paneli  
Elegant and stylish control panel



Müşteriye özel tasarım  
Customer specific design



Değiştirilebilir görsel tasarım  
Changeable visual design



Darbeye dayanıklı, su geçirmez, ön panel  
Impact resistant, waterproof, front panel



Sesli uyan sistemi  
Audible caution system



Uyan aydınlatmaları  
Warning lights



Çalışma voltajı  
(24VAC)  
Operating voltage  
(24VAC)



Su Sayacı Girişi  
Water Meter Input



LED Aydınlatmalı dokunmatik buton  
LED illuminated touch button

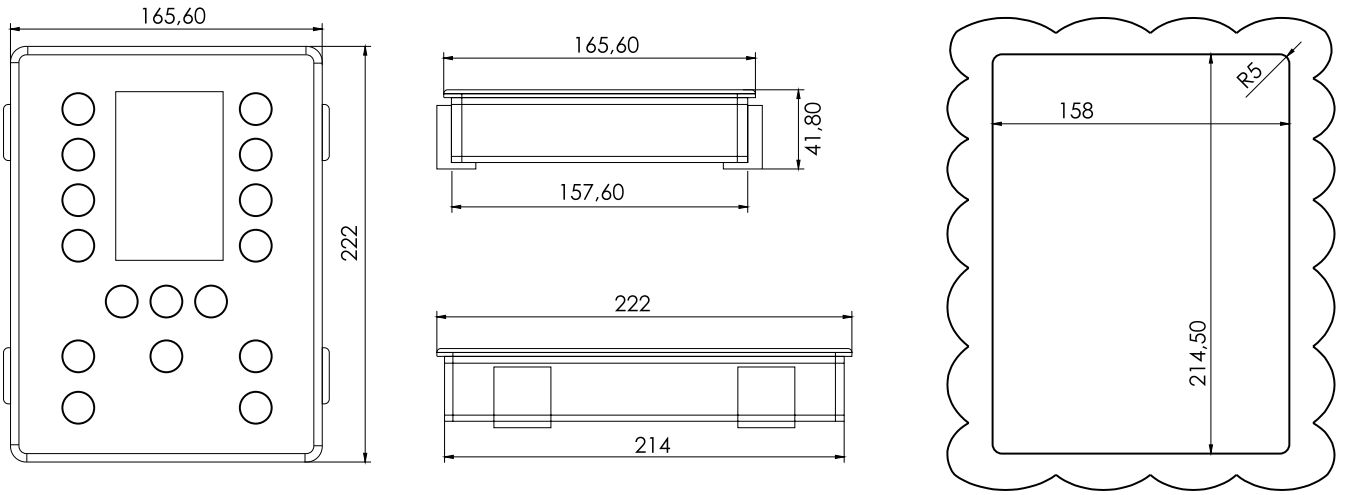

Kesim Ölçüleri / Cutting Dimensions

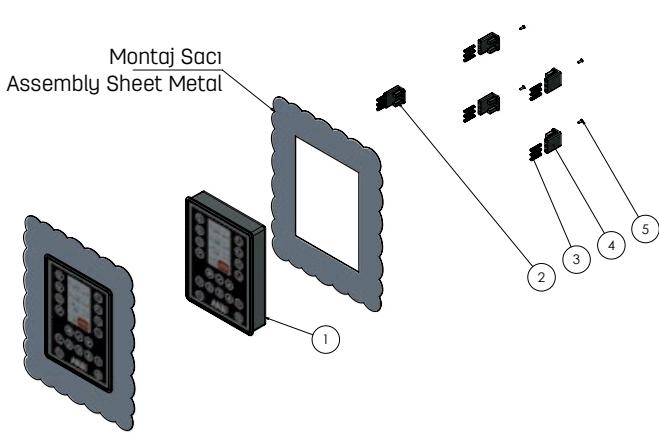

## Teknik Özellikler / Technical Specifications

- 4,3 inch, 480x272px çözünürlüklü, 64k renkli TFT ekran
- 16 adet LED aydınlatmalı dokunmatik buton
- 11 (6+5) adet 2 ortak girişli röle çıkışı (Max: 220VAC-10A)
- 12 adet kuru kontak dijital giriş
- 1 adet NTC girişi
- 1 adet su sayacı girişi
- 24VAC çalışma voltajı
- 4,3 inch, 480x272px resolution, 64k color TFT screen
- 16 units of LED illuminated touch button
- 11 (6+5) units of relay output with 2 common input (Max: 220VAC-10A)
- 12 units of digital input
- 1 unit of NTC input
- 1 unit of water meter input
- 24VAC operating voltage

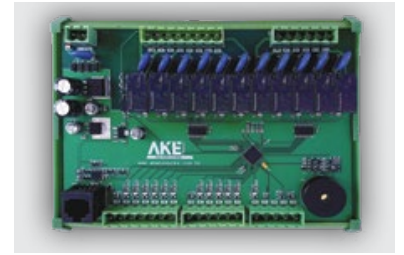
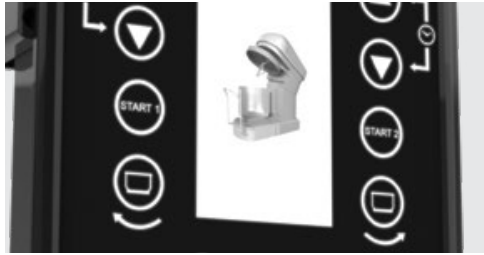

## Örnek uygulama alanları

### Application



Ürün Kodu Product Code	Ürün İsmi Product Name
AKE.343.501.01.01	Mobil Mikser Kontrol Ünitesi / Mobile Mixer Controller
AKE.R001.01.01	Mobil Mikser Röle Kartı / Mobile Mixer I/O Unit

Paket İçeriği  
Package Content

Montaj Aparatları  
Mounting Apparatus



Kullanma Kılavuzu  
User Manuals



Minimum Sipariş Miktarı  
Minimum Order quantity

12 Ad./Pcs

# AKE.324.001



2.4"  
İnç / Inch



64K Renkli TFT Ekran  
Color TFT Screen



Dokunmatik Buton  
Touch Button



Zarif ve şık tasarımlı  
kontrol paneli  
Elegant and stylish  
control panel



Müşteriye özel tasarım  
Customer specific  
design



Değiştirilebilir görsel tasarım  
Changeable visual design

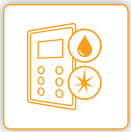

Darbeye dayanıklı, su  
geçirmez, ön panel  
Impact resistant, waterproof,  
front panel



Sesli uyan sistemi  
Audible caution  
system



Uyan aydınlatmaları  
Warning lights



Esnek çalışma voltajı  
(85-305VAC)  
Flexible operating voltage  
(85-305VAC)



Sensör Girişi  
Sensor Input



LED Aydınlatmalı  
dokunmatik buton  
LED illuminated  
touch button

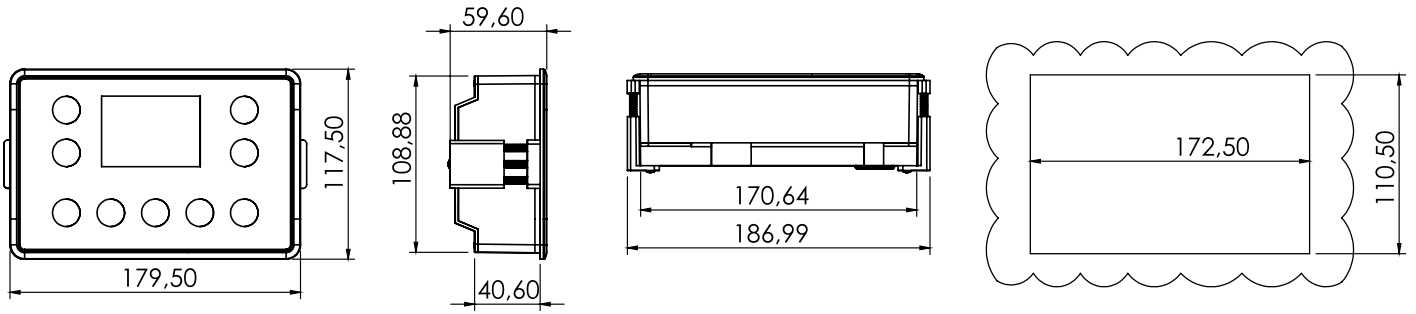

Kesim Ölçüleri / Cutting Dimensions

## Teknik Özellikler / Technical Specifications

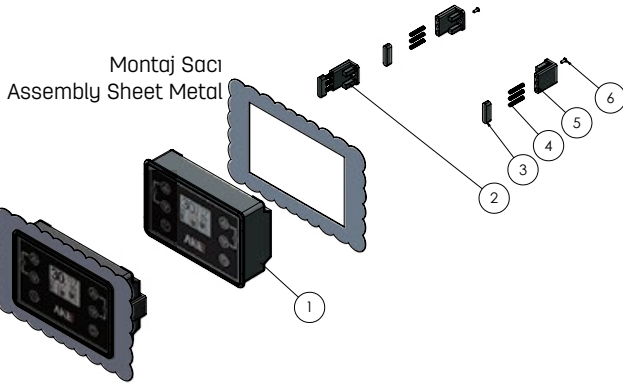

- 2.4" TFT ekran
- 9 adet LED aydınlatmalı dokunmatik buton
- 8 adet ortak girişli role çıkışı
- 6 adet kuru kontak dijital giriş
- 2 adet kuru kontak çıkış
- 1 adet termokupul girişi
- Opsiyonel olarak 0-10V analog giriş, 0-10V analog çıkış veya kablolu NTC okuma
- Sensör Girişi
- 2.4 "TFT screen
- 9 units of LED illuminated touch buttons
- 8 units of relay outputs
- 6 units of contact inputs
- 2 units of contact outputs
- 1 unit of thermocouple input
- Optional 0-10V analogue input, 0-10V analogue output or wired NTC reading
- Sensor input

Örnek uygulama alanları  
Application

Ürün Kodu Product Code	Ürün İsmi Product Name
AKE.324.001.01.01	Hız Ayarlı Mikser Kontrol Ünitesi / Planetary Mixer Controller (Speed Controlled)
AKE.324.001.02.01	Üç Devirli Mikser Kontrol Ünitesi / Planetary Mixer Controller (3 Speed)
AKE.324.001.03.01	Çift Devirli Mikser Kontrol Ünitesi / Planetary Mixer Controller (2 Speed)
AKE.324.001.04.01	Tek Devirli Mikser Kontrol Ünitesi / Planetary Mixer Controller (1 Speed)
AKE.324.001.05.01	Spiral Hamur Yoğurma Makinesi Kontrol Ünitesi / Spiral Dough Mixer Controller

Paket İçeriği  
Package ContentMontaj Aparatları  
Mounting ApparatusKullanma Kılavuzu  
User ManualsMinimum Sipariş Miktarı  
Minimum Order quantity

12 Ad./Pcs

# AKE.324.002



2.4"  
İnç / Inch



64K Renkli TFT Ekran  
Color TFT Screen



Dokunmatik Buton  
Touch Button



Zarif ve şık tasarımlı kontrol paneli  
Elegant and stylish control panel



Müşteriye özel tasarım  
Customer specific design



Değiştirilebilir görsel tasarım  
Changeable visual design

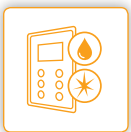

Darbeye dayanıklı, su geçirmez, ön panel  
Impact resistant, waterproof, front panel



Sesli uyan sistemi  
Audible caution system



Uyan aydınlatmaları  
Warning lights



Esnek çalışma voltajı  
(85-305VAC)  
Flexible operating voltage  
(85-305VAC)



Sensör Girişi  
Sensor Input



LED Aydınlatmalı dokunmatik buton  
LED illuminated touch button

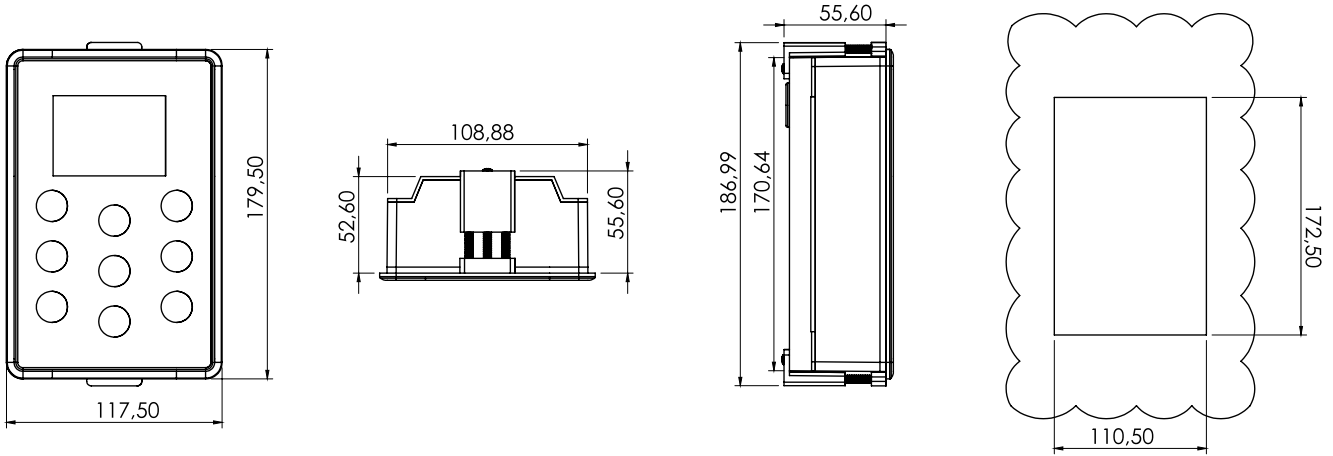

Kesim Ölçüleri / Cutting Dimensions

### Teknik Özellikler / Technical Specifications

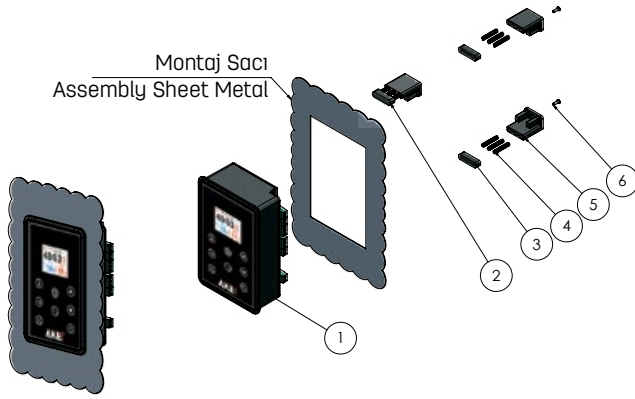

- 2.4" TFT ekran
- 9 adet LED aydınlatmalı dokunmatik buton
- 8 adet ortak girişli role çıkışı
- 6 adet kuru kontak dijital giriş
- 2 adet kuru kontak çıkış
- 1 adet termokupul girişi
- Opsiyonel olarak 0-10V analog giriş, 0-10V analog çıkış veya kablolu NTC okuma
- Sensör Girişi
- 2.4 "TFT screen
- 9 LED illuminated touch buttons
- 8 relay outputs
- 6 contact inputs
- 2 contact outputs
- 1 thermocouple input
- Optional 0-10V analogue input, 0-10V analogue output or wired NTC reading
- Sensor input

### Örnek uygulama alanları Application



Ürün Kodu Product Code	Ürün İsmi Product Name
AKE.324.002.01.01	Hız Ayarlı Mikser Kontrol Ünitesi / Planetary Mixer Controller (Speed Controlled)
AKE.324.002.02.01	Üç Devirli Mikser Kontrol Ünitesi / Planetary Mixer Controller (3 Speed)
AKE.324.002.03.01	Çift Devirli Mikser Kontrol Ünitesi / Planetary Mixer Controller (2 Speed)
AKE.324.002.04.01	Tek Devirli Mikser Kontrol Ünitesi / Planetary Mixer Controller (1 Speed)
AKE.324.002.05.01	Spiral Hamur Yoğurma Makinesi Kontrol Ünitesi / Spiral Dough Mixer Controller

Paket İçeriği  
Package Content

Montaj Aparatları  
Mounting Apparatus



Kullanma Kılavuzu  
User Manuals



Minimum Sipariş Miktarı  
Minimum Order quantity

12 Ad./Pcs

# AKE.207.001



7 Segment Ekran  
Segment Display



Dokunmatik Buton  
Touch Button



Zarif ve şık tasarımlı kontrol paneli  
Elegant and stylish control panel



Müşteriye özel tasarım  
Customer specific design



Değiştirilebilir görsel tasarım  
Changeable visual design



Darbeye dayanıklı, su geçirmez, ön panel  
Impact resistant, waterproof, front panel



Sesli uyan sistemi  
Audible caution system



Uyan aydınlatmaları  
Warning lights



Çalışma voltajı  
(220-240VAC)  
Operating voltage  
(220-240VAC)



7 segment ekran  
7 segment display

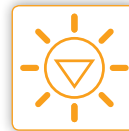

LED Aydınlatmalı dokunmatik buton  
LED illuminated touch button

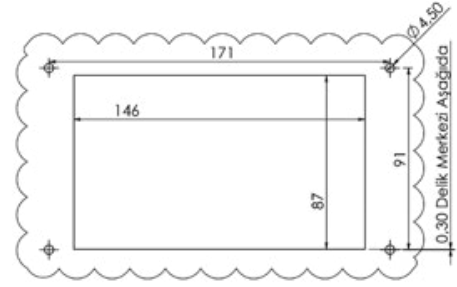
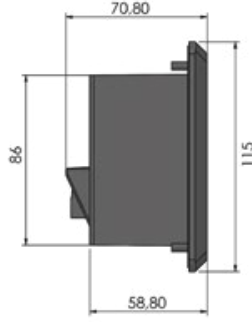
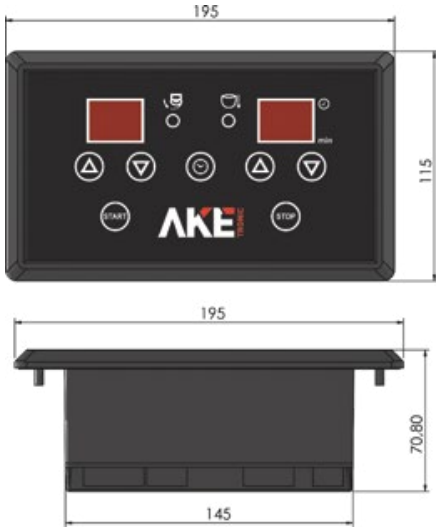

Kesim Ölçüleri / Cutting Dimensions

### Teknik Özellikler / Technical Specifications

Montaj Sacı  
Assembly Sheet Metal

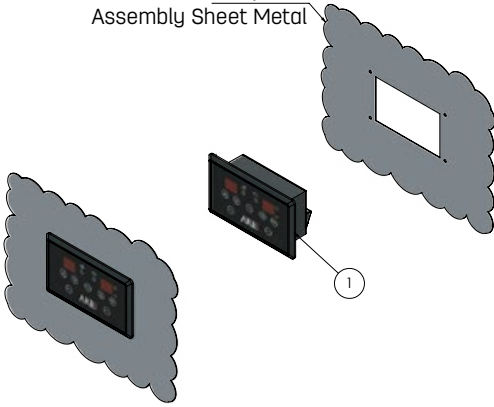

- 2 adet 2 basamaklı 7 segment display
- 2 units of 2 digits 7 segment display
- 7 adet LED aydınlatmalı dokunmatik buton
- 7 units of LED illuminated touch button
- 3 adet ortak girişli röle çıkışı (Max: 220VAC-5A)
- 3 units of common input relay output (Max: 220VAC-5A)
- 3 adet kuru kontak dijital giriş
- 3 units of digital input
- 220-240VAC çalışma voltajı
- 220-240VAC operating voltage
- Sesli uyan sistemi
- Alarm buzzer
- 2 adet uyan ledi
- 2 units of warning led

### Örnek uygulama alanları Application

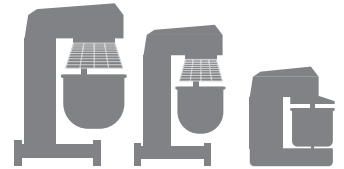

Ürün Kodu Product Code	Ürün İsmi Product Name
AKE.207001.01.01	Hız Ayarlı Mikser Kontrol Ünitesi / Planetary Mixer Controller (Speed Controlled)
AKE.207001.02.01	Üç Devirli Mikser Kontrol Ünitesi / Planetary Mixer Controller (3 Speed)
AKE.207001.03.01	Çift Devirli Mikser Kontrol Ünitesi / Planetary Mixer Controller (2 Speed)
AKE.207001.04.01	Tek Devirli Mikser Kontrol Ünitesi / Planetary Mixer Controller (1 Speed)
AKE.207001.05.01	Spiral Hamur Yoğurma Makinesi Kontrol Ünitesi / Spiral Dough Mixer Controller

Paket İçeriği  
Package Content

Montaj Aparatları  
Mounting Apparatus



Kullanma Kılavuzu  
User Manuals



Minimum Sipariş Miktarı  
Minimum Order quantity

12 Ad./Pcs

# AKE.207.002



7 Segment Ekran  
Segment Display



Dokunmatik Buton  
Touch Button



Zarif ve şık tasarımlı kontrol paneli  
Elegant and stylish control panel



Müşteriye özel tasarım  
Customer specific design



Değiştirilebilir görsel tasarım  
Changeable visual design



Darbeye dayanıklı, su geçirmez, ön panel  
Impact resistant, waterproof, front panel



Sesli uyan sistemi  
Audible caution system



Uyan aydınlatmaları  
Warning lights



Çalışma voltajı  
(220-240VAC)  
Operating voltage  
(220-240VAC)



7 segment ekran  
7 segment display



LED Aydınlatmalı dokunmatik buton  
LED illuminated touch button

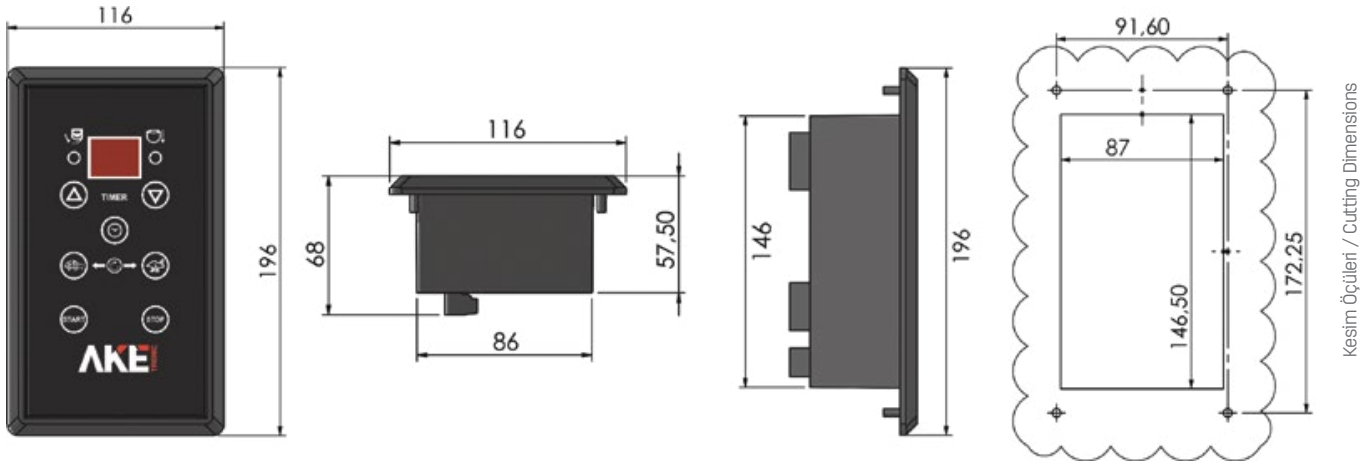

Montaj Sacı  
Assembly Sheet Metal

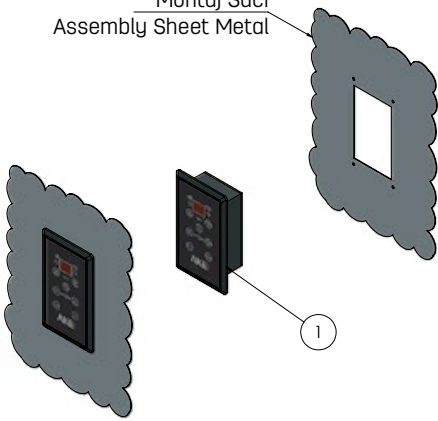

### Teknik Özellikler / Technical Specifications

- 1 adet 2 basamaklı 7 segment display
- 7 adet LED aydınlatmalı dokunmatik buton
- 2 adet ortak girişli röle çıkışı (Max: 220VAC-5A)
- 3 adet kuru kontak dijital giriş
- 220-240VAC çalışma voltajı
- Sesli uyan sistemi
- 2 adet uyan ledi
- 1 unit of 2 digits 7 segment display
- 7 units of LED illuminated touch button
- 2 units of common input relay output (Max: 220VAC-5A)
- 3 units of digital input
- 220-240VAC operating voltage
- Alarm buzzer
- 2 units of warning led

### Örnek uygulama alanları Application

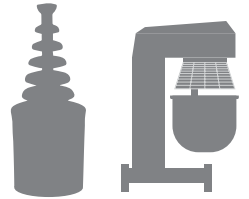

Ürün Kodu Product Code	Ürün İsmi Product Name
AKE.207002.01.01	Çift Devirli Mikser Kontrol Ünitesi / Planetary Mixer Controller (2 Speed)
AKE.207002.02.01	Çikolata Şelale Makinası Kontrol Ünitesi / Chocolate Fountain Controller

### Paket İçeriği Package Content

Montaj Aparatları  
Mounting Apparatus



Kullanma Kılavuzu  
User Manuals



Minimum Sipariş Miktarı  
Minimum Order quantity

12 Ad./Pcs

# AKE.324.003



2.4"  
İnç / Inch



64K Renkli TFT Ekran  
Color TFT Screen



Dokunmatik Buton  
Touch Button



Zarif ve şık tasarımlı kontrol paneli  
Elegant and stylish control panel



Müşteriye özel tasarım  
Customer specific design



Değiştirilebilir görsel tasarım  
Changeable visual design



Darbeye dayanıklı, su geçirmez, ön panel  
Impact resistant, waterproof, front panel



Sesli uyan sistemi  
Audible caution system



Uyan aydınlatmaları  
Warning lights



Esnek çalışma voltajı  
(85-305VAC)  
Flexible operating voltage  
(85-305VAC)



LED Aydınlatmalı dokunmatik buton  
LED illuminated touch button

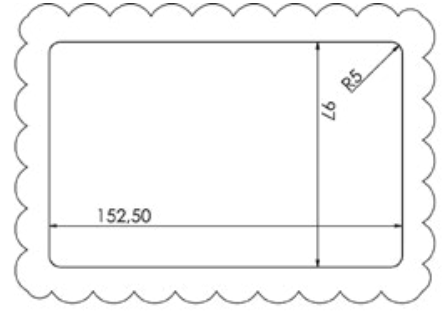
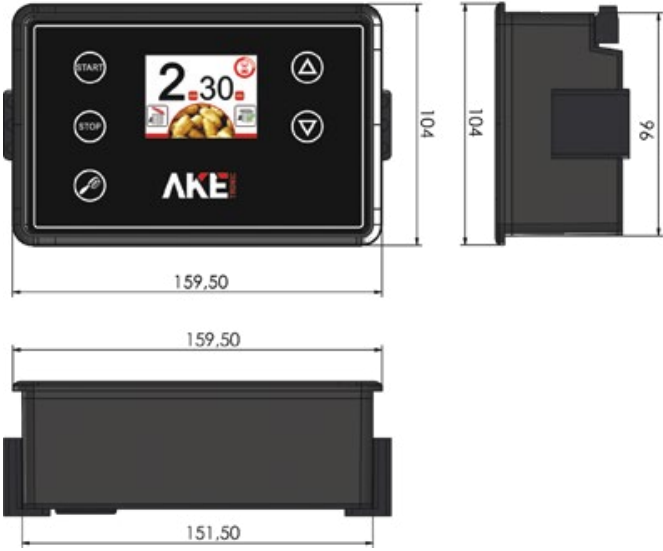

Kesim Ölçüleri / Cutting Dimensions

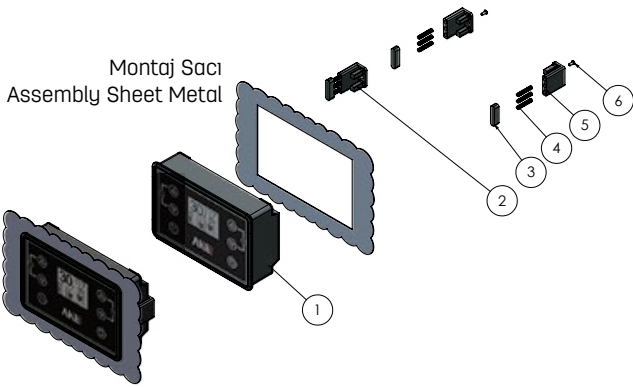

## Teknik Özellikler / Technical Specifications

- 2.4" TFT ekran
- 5 ad. LED aydınlatmalı dokunmatik buton
- 2 ad. ortak girişli röle çıkışı
- 2 ad. kuru kontak çıkış
- 1 ad. termokupul girişi
- 2.4 "TFT screen
- 5 LED illuminated touch buttons
- 2 relay outputs
- 2 contact outputs
- 1 unit thermocouple input

Örnek uygulama alanları  
Application

Ürün Kodu Product Code	Ürün İsmi Product Name
---------------------------	---------------------------

AKE.324.003.01.01 Patates Soyma Makinesi Kontrol Ünitesi / Potato Peeler Controller

Paket İçeriği  
Package Content

Montaj Aparatları  
Mounting Apparatus



Kullanma Kılavuzu  
User Manuals



Minimum Sipariş Miktarı  
Minimum Order quantity

12 Ad./Pcs

# AKE.324.004



2.4"  
İnç / Inch



64K Renkli TFT Ekran  
Color TFT Screen



Dokunmatik Buton  
Touch Button



Zarif ve şık tasarımlı kontrol paneli  
Elegant and stylish control panel



Müşteriye özel tasarım  
Customer specific design



Değiştirilebilir görsel tasarım  
Changeable visual design



Darbeye dayanıklı, su geçirmez, ön panel  
Impact resistant, waterproof, front panel



Sesli uyan sistemi  
Audible caution system



Uyan aydınlatmaları  
Warning lights



Esnek çalışma voltajı  
(85-305VAC)  
Flexible operating voltage  
(85-305VAC)



LED Aydınlatmalı dokunmatik buton  
LED illuminated touch button

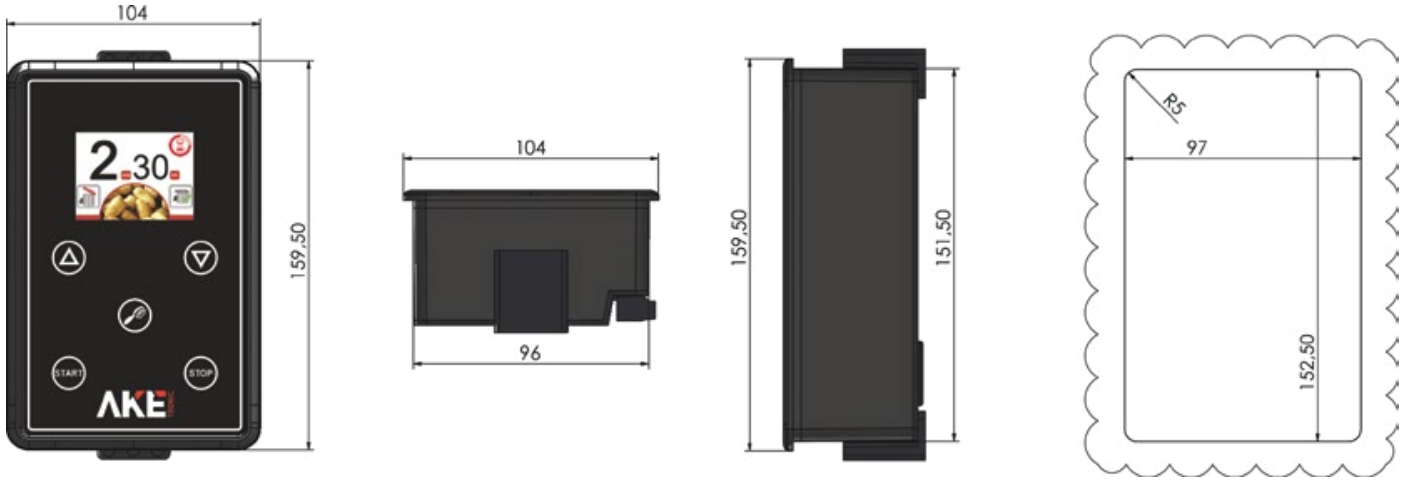

Kesim Ölçüleri / Cutting Dimensions

## Teknik Özellikler / Technical Specifications

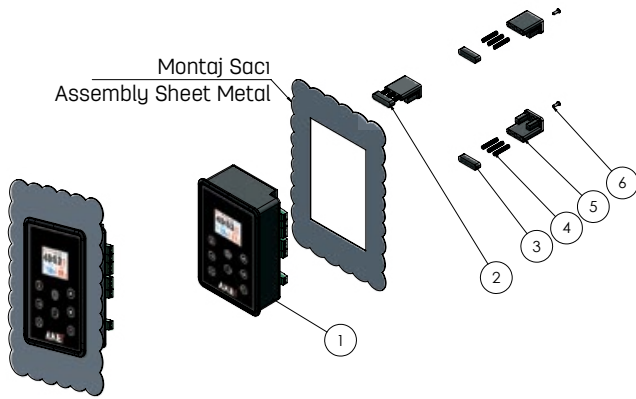

- 2.4" TFT ekran
- 5 adet LED aydınlatmalı dokunmatik buton
- 2 adet ortak girişli role çıkışı
- 2 adet kuru kontak çıkışı
- 1 adet termokupul girişi
- 2.4" TFT screen
- 5 LED illuminated touch buttons
- 2 relay outputs
- 2 contact outputs
- 1 unit thermocouple input

### Örnek uygulama alanları Application



Ürün Kodu Product Code	Ürün İsmi Product Name
---------------------------	---------------------------

AKE.324.004.01.01 Patates Soyma Makinesi Kontrol Ünitesi / Potato Peeler Controller

Paket İçeriği  
Package Content

Montaj Aparatları  
Mounting Apparatus ✓

Kullanma Kılavuzu  
User Manuals ✓

Minimum Sipariş Miktarı  
Minimum Order quantity

12 Ad./Pcs

# AKE.207.003



7 Segment Ekran  
Segment Display



Dokunmatik Buton  
Touch Button



Zarif ve şık tasarımlı kontrol paneli  
Elegant and stylish control panel



Müşteriye özel tasarım  
Customer specific design



Değiştirilebilir görsel tasarım  
Changeable visual design



Darbeye dayanıklı, su geçirmez, ön panel  
Impact resistant, waterproof, front panel



Sesli uyan sistemi  
Audible caution system



Uyan aydınlatmaları  
Warning lights



Çalışma voltajı  
(220-240VAC)  
Operating voltage  
(220-240VAC)



7 segment ekran  
7 segment display

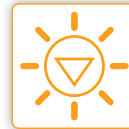

LED Aydınlatmalı dokunmatik buton  
LED illuminated touch button

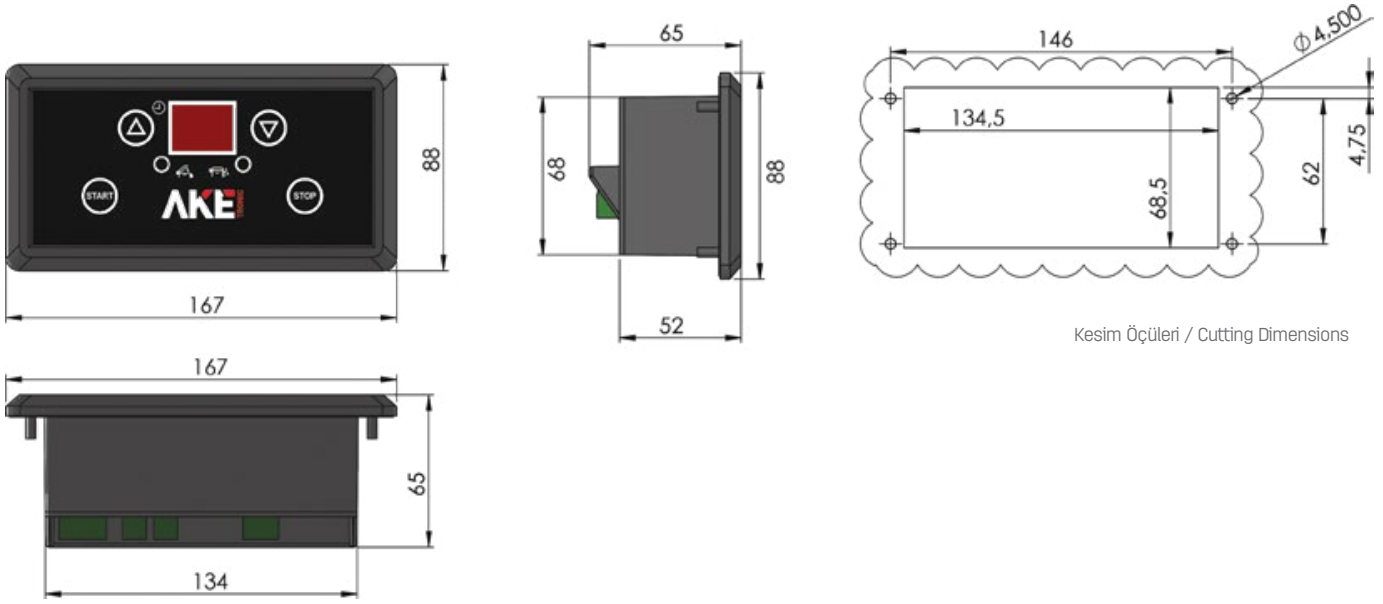

## Teknik Özellikler / Technical Specifications

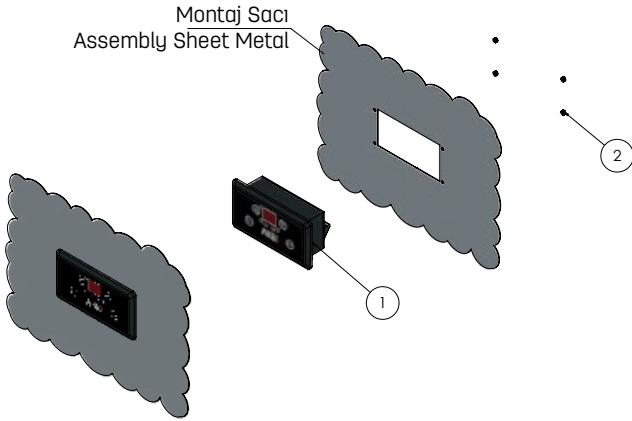

- 1 adet 2 basamaklı 7 segment display
- 1 unit of 2 digits 7 segment display
- 4 adet LED aydınlatmalı dokunmatik buton
- 4 units of LED illuminated touch button
- 2 adet kuru kontak röle çıkışı (Max: 220VAC-5A)
- 2 units of dry contact relay output (Max: 220VAC-5A)
- 3 adet kuru kontak dijital giriş
- 3 units of digital input
- 220-240VAC çalışma voltajı
- 220-240VAC operating voltage
- Sesli uyan sistemi
- Alarm buzzer
- 2 adet uyan ledi
- 2 units of warning led

## Örnek uygulama alanları Application



Ürün Kodu  
Product Code

Ürün İsmi  
Product Name

AKE.207.003.01.01

Patates Soyma Makinesi Kontrol Ünitesi / Potato Peeler Controller

Paket İçeriği  
Package Content

Montaj Aparatları  
Mounting Apparatus



Kullanma Kılavuzu  
User Manuals



Minimum Sipariş Miktarı  
Minimum Order quantity

12 Ad./Pcs

# AKE.207.004



7 Segment Ekran  
Segment Display



Dokunmatik  
Buton  
Touch Button



Zarif ve şık tasarımlı  
kontrol paneli  
Elegant and stylish  
control panel



Müşteriye özel tasarım  
Customer specific  
design



Değiştirilebilir görsel tasarım  
Changeable visual design



Darbeye dayanıklı, su  
geçirmez, ön panel  
Impact resistant, waterproof,  
front panel



Sesli uyan sistemi  
Audible caution  
system



Uyan aydınlatmaları  
Warning lights



Çalışma voltajı  
(24VAC)  
Operating voltage  
(24VAC)



7 segment ekran  
7 segment display



LED Aydınlatmalı  
dokunmatik buton  
LED illuminated  
touch button

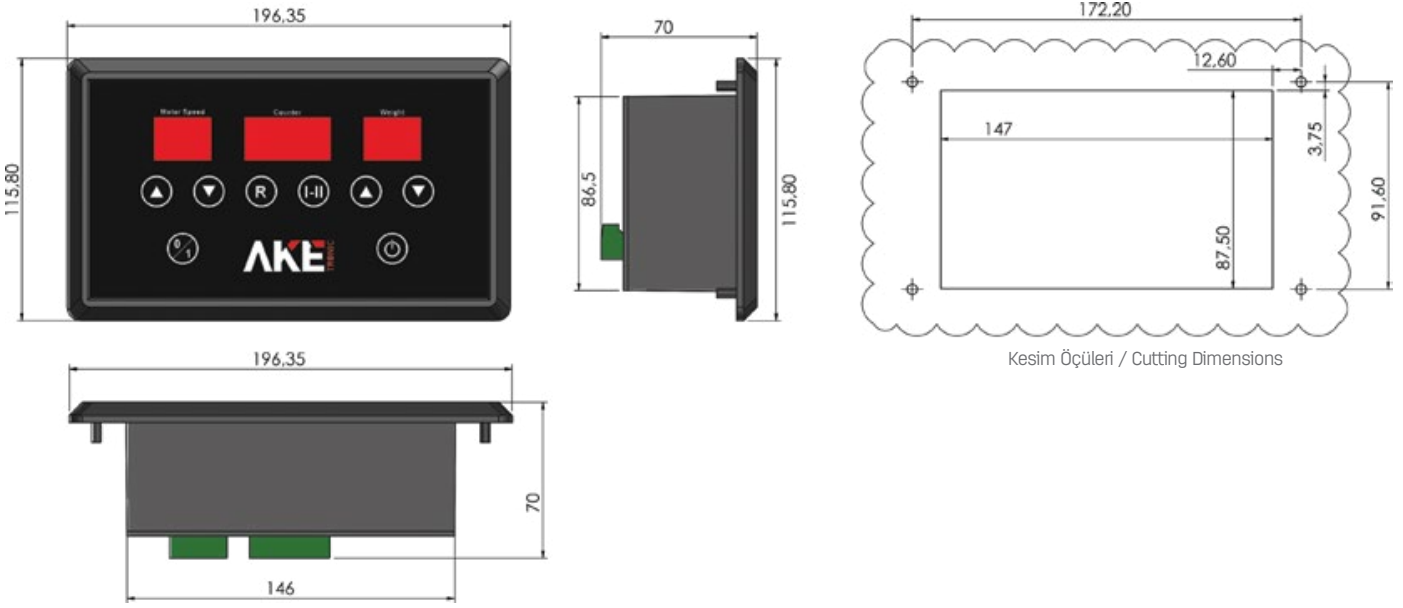

### Teknik Özellikler / Technical Specifications

Montaj Sacı  
Assembly Sheet Metal

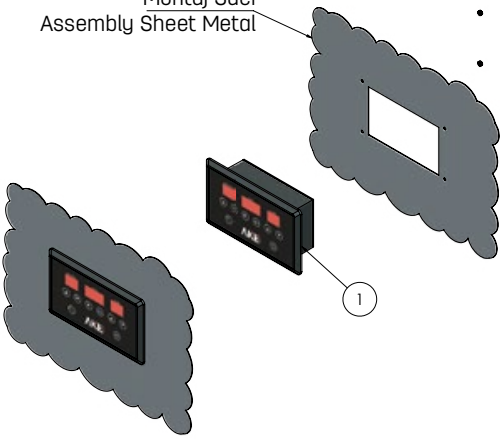

- 1 adet 3 basamaklı 7 segment display
- 2 adet 2 basamaklı 7 segment display
- 8 adet LED aydınlatmalı dokunmatik buton
- 2 adet kuru kontak röle çıkışı (Max: 220VAC-5A)
- 2 adet ortak girişli röle çıkışı (Max: 220VAC-5A)
- 1 adet 0-10V analog çıkış (Hız kontrol cihazı için)
- 1 adet kuru kontak dijital giriş (Hız kontrol cihazı için)
- 1 adet endüktif sensör girişi
- 24VAC çalışma voltajı
- 1 unit of 3-stage 7 segment display
- 2 units of 2 digits 7 segment display
- 8 units of LED illuminated touch button
- 2 units of dry contact relay output (Max: 220VAC-5A)
- 2 units of common input relay output (Max: 220VAC-5A)
- 1 unit of 0-10V analog output (for Speed Control device)
- 1 unit of digital input (for Speed Control device)
- 1 unit of inductive sensor input
- 24VAC operating voltage

### Örnek uygulama alanları Application



Ürün Kodu  
Product Code

Ürün İsmi  
Product Name

AKE.207004.01.01

Kestart Makinesi Kontrol Ünitesi / Volumetric Dough Divider

Paket İçeriği  
Package Content

Montaj Aparatları  
Mounting Apparatus



Kullanma Kılavuzu  
User Manuals



Minimum Sipariş Miktarı  
Minimum Order quantity

12 Ad./Pcs

# AKE.207.005



7 Segment Ekran  
Segment Display



Dokunmatik  
Buton  
Touch Button



Zarif ve şık tasarımlı  
kontrol paneli  
Elegant and stylish  
control panel



Müşteriye özel tasarım  
Customer specific  
design



Değiştirilebilir görsel tasarım  
Changeable visual design



Darbeye dayanıklı, su  
geçirmez, ön panel  
Impact resistant, waterproof,  
front panel



Sesli uyan sistemi  
Audible caution  
system



Uyan aydınlatmaları  
Warning lights



Çalışma voltajı  
(24VAC)  
Operating voltage  
(24VAC)



7 segment ekran  
7 segment display

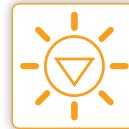

LED Aydınlatmalı  
dokunmatik buton  
LED illuminated  
touch button

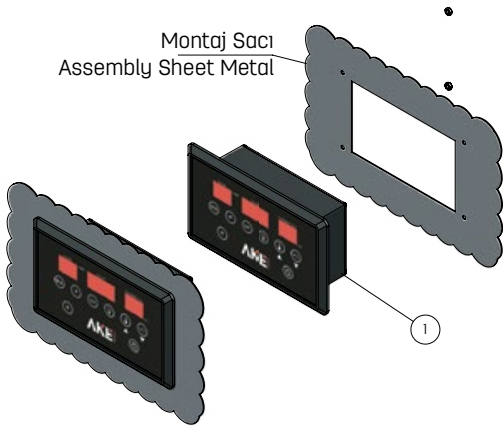
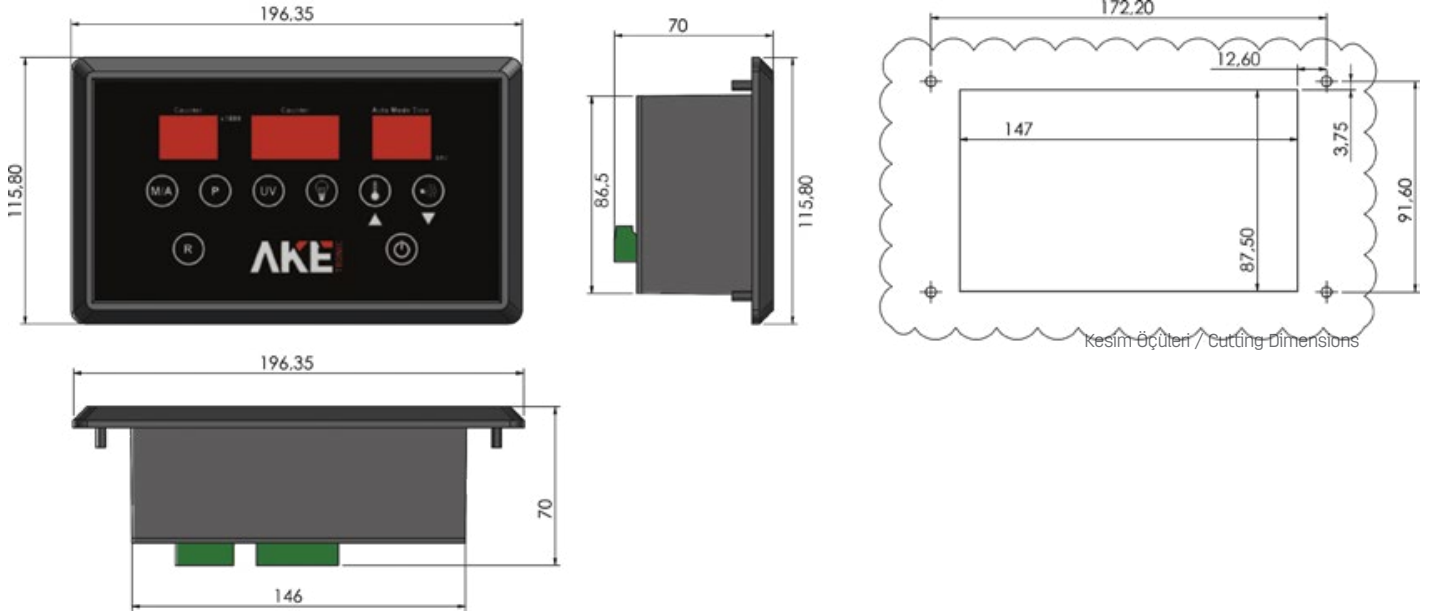

### Teknik Özellikler / Technical Specifications

- 1 adet 3 basamaklı 7 segment display
- 2 adet 2 basamaklı 7 segment display
- 8 adet LED aydınlatmalı dokunmatik buton
- 5 adet ortak girişli röle çıkışı (Max: 220VAC-5A)
- 1 adet motor rölesi çıkışı (12 VDC)
- 6 adet kuru kontak dijital giriş
- 2 adet endüktif sensör girişi
- 24VAC çalışma voltajı
- 1 unit of 3-stage 7 segment display
- 2 units of 2 digits 7 segment display
- 8 units of LED illuminated touch button
- 5 units of common input relay output (Max: 220VAC-5A)
- 1 unit of motor relay output (12 VDC)
- 6 units of digital input
- 2 units of inductive sensor input
- 24VAC operating voltage

### Örnek uygulama alanları Application



Ürün Kodu Product Code	Ürün İsmi Product Name
---------------------------	---------------------------

AKE.207005.01.01 Ara Dinlendirme Makinesi Kontrol Ünitesi / Dough Proofing Machine Controller

Paket İçeriği  
Package Content

Montaj Aparatları  
Mounting Apparatus



Kullanma Kılavuzu  
User Manuals



Minimum Sipariş Miktarı  
Minimum Order quantity

12 Ad./Pcs



AKE



SET



# Bulaşık Yıkama Makinesi Kontrol Üniteleri Controllers For Dishwashers

Bulaşık Yıkama Makinesi Kontrol Ünitesi  
Advance Dishwasher Controller Advance

Bulaşık Yıkama Makinesi Kontrol Ünitesi  
Dishwasher Controller

Bulaşık Yıkama Makinesi Kontrol Ünitesi Colour Plus  
Dishwasher Controller Colour Plus

Bulaşık Yıkama Makinesi Kontrol Ünitesi  
Dishwasher Controller

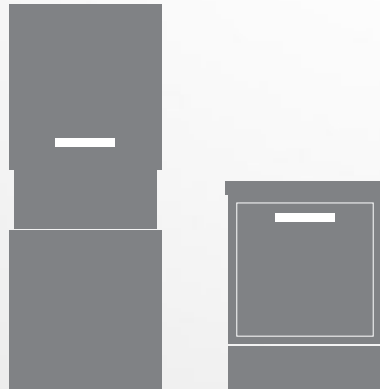

# AKE.324.501



2.4"  
İnç / Inch



64K Renkli TFT Ekran  
Color TFT Screen



Dokunmatik Buton  
Touch Button



Ekran I/O kart ile birlikte çalışmaktadır.  
The display unit can work with I/O units



Zarif ve şık tasarımlı kontrol paneli  
Elegant and stylish control panel



Müşteriye özel tasarım  
Customer specific design



Değiştirilebilir görsel tasarım  
Changeable visual design



Darbeye dayanıklı, su geçirmez, ön panel  
Impact resistant, waterproof, front panel



Sesli uyan sistemi  
Audible caution system



Uyan aydınlatmaları  
Warning lights



Esnek çalışma voltajı (85-305VAC)  
Flexible operating voltage (85-305VAC)



LED Aydınlatmalı dokunmatik buton  
LED illuminated touch button



Farklı I/O kartlarla çalışma imkanı  
Opportunity to work with different I/O units

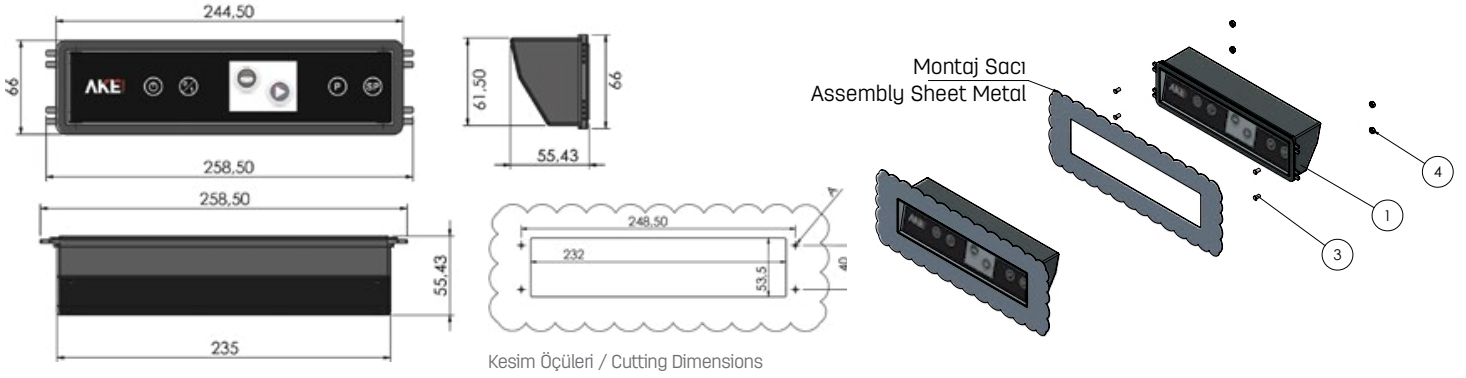

## Uyumlu I/O Üniteleri Matching I/O Units

Ürün Kodu Product Code	Ürün İsmi Product Name	Teknik Özellikler Technical Specifications
AKE.324.501	Bulaşık Yıkama Makinesi Kontrol Ünitesi Ekranı Dishwasher Controller Display	<ul style="list-style-type: none"> <li>• 2,4 inch, 320x240px çözünürlüklü, 16 milyon renkli TFT ekran 2,4 inch, 320x240px resolution, 16 million color TFT screen</li> <li>• 4 adet LED aydınlatmalı dokunmatik buton 4 units of LED illuminated touch button</li> </ul>
AKE.R002.01.01	Advanced Bulaşık Yıkama Makinesi Röle Kartı Dishwasher I/O Unit	<ul style="list-style-type: none"> <li>• 1 adet ortak girişli röle çıkışı (Max: 220VAC-30A) 1 unit of common input relay output (Max: 220VAC-30A)</li> <li>• 1 adet motor hız kontrol çıkışı 1 unit of motor speed control output</li> <li>• 2 adet analog giriş (Su seviye için) 2 units of analog input (for water level)</li> </ul> <p><i>Detaylı bilgi için Sayfa 74'e bakabilirsiniz. See page 74 for details.</i></p>
AKE.R003.01.01	Premium Bulaşık Yıkama Makinesi Röle Kartı Dishwasher I/O Unit	<ul style="list-style-type: none"> <li>• 3 adet ortak girişli röle çıkışı (Max: 220VAC-30A) 3 units of common input relay output (Max: 220VAC-30A)</li> <li>• 2 adet akım korumalı 220VAC çıkış (Max: 30A) 2 units of current protected 220VAC output (Max: 30A)</li> </ul> <p><i>Detaylı bilgi için Sayfa 75'e bakabilirsiniz. See page 75 for details.</i></p>
AKE.R004.01.01	Plus Bulaşık Yıkama Makinesi Röle Kartı Dishwasher I/O Unit	<ul style="list-style-type: none"> <li>• 8 adet çıkış kontağı (Max: 230VAC) 8 units output contact (Max: 230VAC)</li> <li>• 180 saniye tahliye süresi 180 second drain time</li> <li>• Raya montaj bağlantı şekli Rack mounting connection mode</li> </ul> <p><i>Detaylı bilgi için Sayfa 76'ya bakabilirsiniz. See page 76 for details.</i></p>
AKE.R004.02.01	Bulaşık Yıkama Makinesi Röle Kartı Dishwasher I/O Unit	<ul style="list-style-type: none"> <li>• 6 adet çıkış kontağı (Max: 230VAC) 6 units output contact (Max: 230VAC)</li> <li>• 180 saniye tahliye süresi 180 second drain time</li> <li>• Raya montaj bağlantı şekli Rack mounting connection mode</li> </ul> <p><i>Detaylı bilgi için Sayfa 77'ye bakabilirsiniz. See page 77 for details.</i></p>

Paket İçeriği  
Package Content

Montaj Aparatları  
Mounting Apparatus



Kullanma Kılavuzu  
User Manuals



Minimum Sipariş Miktarı  
Minimum Order quantity

12 Ad./Pcs

# AKE.207.501



7 Segment Ekran  
Segment Display



Dokunmatik Buton  
Touch Button



Ekran I/O kart ile birlikte  
çalışmaktadır.  
The display unit can work  
with I/O units



Zarif ve şık tasarımlı  
kontrol paneli  
Elegant and stylish  
control panel



Müşteriye özel tasarım  
Customer specific  
design



Değiştirilebilir görsel tasarım  
Changeable visual design



Darbeye dayanıklı, su  
geçirmez, ön panel  
Impact resistant, waterproof,  
front panel



Sesli uyan sistemi  
Audible caution  
system



Uyan aydınlatmaları  
Warning lights



Çalışma voltajı  
(230VAC)  
Operating voltage  
(230VAC)



LED Aydınlatmalı  
dokunmatik buton  
LED illuminated  
touch button



Farklı I/O kartlarla  
çalışma imkanı  
Opportunity to work with  
different I/O units

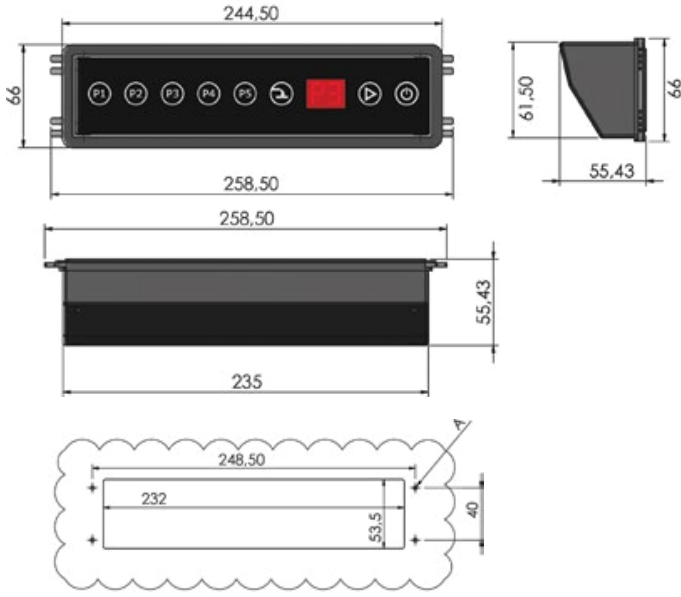

Kesim Ölçüleri / Cutting Dimensions

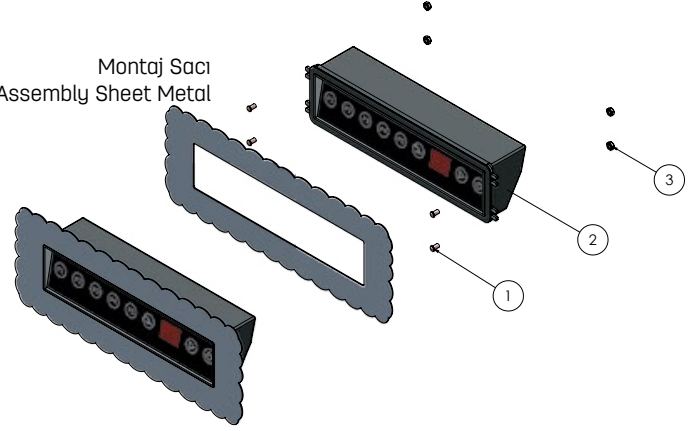
Montaj Sacı  
Assembly Sheet Metal

## Uyumlu I/O Kartlar

Ürün Kodu Product Code	Ürün İsmi Product Name	Teknik Özellikler Technical Specifications
AKE.207501	Bulaşık Yıkama Makinesi Kontrol Ünitesi Ekranı Dishwasher Controller Display	<ul style="list-style-type: none"> <li>2 basamaklı 7 segment display 2 large digits 7 segment display</li> <li>8 adet LED aydınlatmalı dokunmatik buton 8 units of LED illuminated touch button</li> </ul>
AKE.R004.01.01	Plus Bulaşık Yıkama Makinesi Röle Kartı Dishwasher I/O Unit	<ul style="list-style-type: none"> <li>8 adet çıkış kontağı (Max: 230VAC) 8 units output contact (Max: 230VAC)</li> <li>180 saniye tahliye süresi 180 second drain time</li> <li>Raya montaj bağlantı şekli Rack mounting connection mode</li> </ul>
AKE.R004.02.01	Bulaşık Yıkama Makinesi Röle Kartı Dishwasher I/O Unit	<ul style="list-style-type: none"> <li>6 adet çıkış kontağı (Max: 230VAC) 6 units output contact (Max: 230VAC)</li> <li>180 saniye tahliye süresi 180 second drain time</li> <li>Raya montaj bağlantı şekli Rack mounting connection mode</li> </ul>

Detaylı bilgi için Sayfa 76'ya bakabilirsiniz. See page 76 for details.

Detaylı bilgi için Sayfa 77'ye bakabilirsiniz. See page 77 for details.

Paket İçeriği  
Package ContentMontaj Aparatları  
Mounting ApparatusKullanma Kılavuzu  
User ManualsMinimum Sipariş Miktarı  
Minimum Order quantity

12 Ad./Pcs

# AKE.107.501



7 Segment Ekran  
Segment Display



Donanımsal Buton  
Hardware Button



Etiket ve kutu görsel amaçlıdır.  
Paket içeriğinde yer almamaktadır.  
The label and box are for visual purposes.  
Not included in the package content.



Ekran I/O kart ile birlikte  
çalışmaktadır.  
The display unit can work  
with I/O units



Zarif ve şık tasarımlı  
kontrol paneli  
Elegant and stylish  
control panel



Müşteriye özel tasarım  
Customer specific  
design



Değiştirilebilir görsel tasarım  
Changeable visual design



Darbeye dayanıklı, su  
geçirmez, ön panel  
Impact resistant, waterproof,  
front panel



Sesli uyan sistemi  
Audible caution  
system



Uyan aydınlatmaları  
Warning lights



Çalışma voltajı  
(230VAC)  
Operating voltage  
(230VAC)



LED Aydınlatmalı  
dokunmatik buton  
LED illuminated  
touch button



Farklı I/O kartlarla  
çalışma imkanı  
Opportunity to work with  
different I/O units

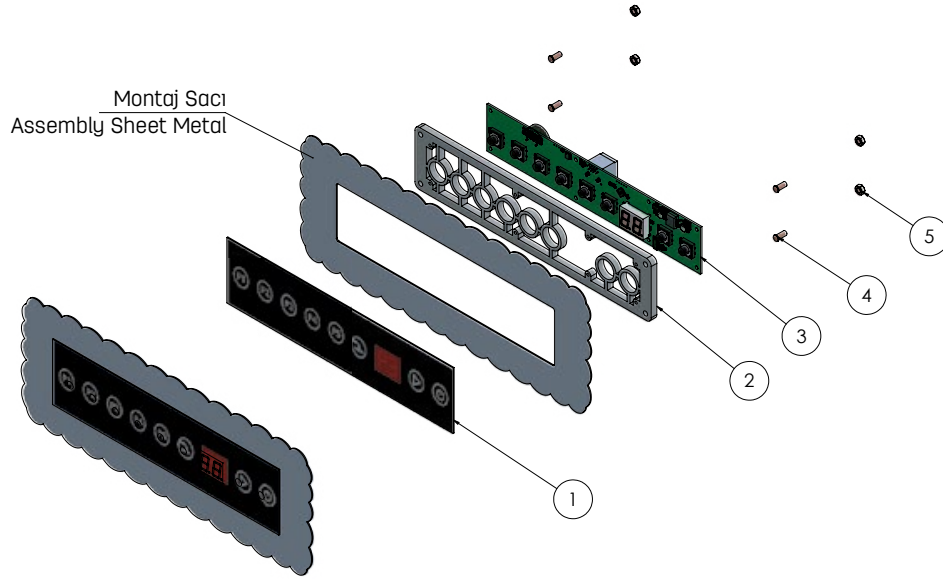

## Uyumlu I/O Kartlar

Ürün Kodu Product Code	Ürün İsmi Product Name	Teknik Özellikler Technical Specifications
AKE.107.501	Bulaşık Yıkama Makinesi Kontrol Ünitesi Ekranı Dishwasher Controller Display	<ul style="list-style-type: none"> <li>2 basamaklı 7 segment display 2 large digits 7 segment display</li> <li>8 adet LED aydınlatmalı dokunmatik buton 8 units of LED illuminated touch button</li> </ul>
AKE.R004.01.01	Plus Bulaşık Yıkama Makinesi Röle Kartı Dishwasher I/O Unit	<ul style="list-style-type: none"> <li>8 adet çıkış kontağı (Max: 230VAC) 8 units output contact (Max: 230VAC)</li> <li>180 saniye tahliye süresi 180 second drain time</li> <li>Raya montaj bağlantı şekli Rack mounting connection mode</li> </ul>
AKE.R004.02.01	Bulaşık Yıkama Makinesi Röle Kartı Dishwasher I/O Unit	<ul style="list-style-type: none"> <li>6 adet çıkış kontağı (Max: 230VAC) 6 units output contact (Max: 230VAC)</li> <li>180 saniye tahliye süresi 180 second drain time</li> <li>Raya montaj bağlantı şekli Rack mounting connection mode</li> </ul>

Detaylı bilgi için Sayfa 76'ya bakabilirsiniz. See page 76 for details.

Detaylı bilgi için Sayfa 77'ye bakabilirsiniz. See page 77 for details.

Paket İçeriği  
Package Content

Montaj Aparatları  
Mounting Apparatus ✓

Kullanma Kılavuzu  
User Manuals ✓

Kutu ve Etiket Dahil Değildir  
Box and Label Not Included ✗

Minimum Sipariş Miktarı  
Minimum Order Quantity 12 Ad./Pcs

# AKE.R002.01.01

Advanced

Bulaşık Yıkama Makinesi Röle Kartı  
Dishwasher I/O Unit

Bulaşık Yıkama Makinesi Kontrol Üniteleri | Controllers For Dishwashers

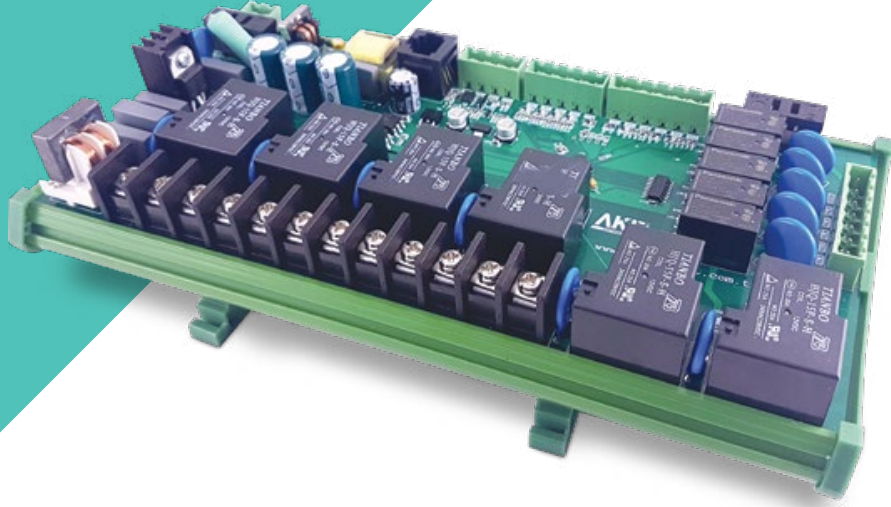

Motor kalkış rampa özelliği  
Motor start ramp feature

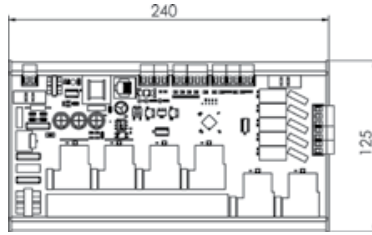

## Teknik Özellikler / Technical Specifications

- 1 adet ortak girişli röle çıkışı (Max: 220VAC-30A)
- 5 adet ortak girişli röle çıkışı (Max: 220VAC-10A)
- 4 adet kuru kontak röle çıkışı (Max: 220VAC-30A)
- 1 adet motor hız kontrol çıkışı
- 4 adet kuru kontak dijital giriş
- 2 adet analog giriş (Su seviye için)
- 2 adet NTC girişi
- 85-305VAC çalışma voltajı
- 1 unit of common input relay output (Max: 220VAC-30A)
- 5 units of common input relay output (Max: 220VAC-10A)
- 4 units of dry contact relay output (Max: 220VAC-30A)
- 1 unit of motor speed control output
- 4 units of digital input
- 2 units of analog input (for water level)
- 2 units of NTC input
- 85-305VAC operating voltage

## Örnek uygulama alanları Application



Ürün Kodu  
Product Code

Ürün İsmi  
Product Name

AKE.R002.01.01

Bulaşık Yıkama Makinesi Röle Kartı (Advanced) / Dishwasher I/O Unit (Advanced)

Paket İçeriği  
Package Content

Montaj Aparatları  
Mounting Apparatus



Kullanma Kılavuzu  
User Manuals



Minimum Sipariş Miktarı  
Minimum Order quantity

12 Ad./Pcs

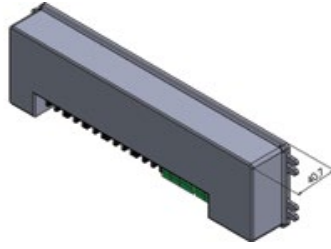
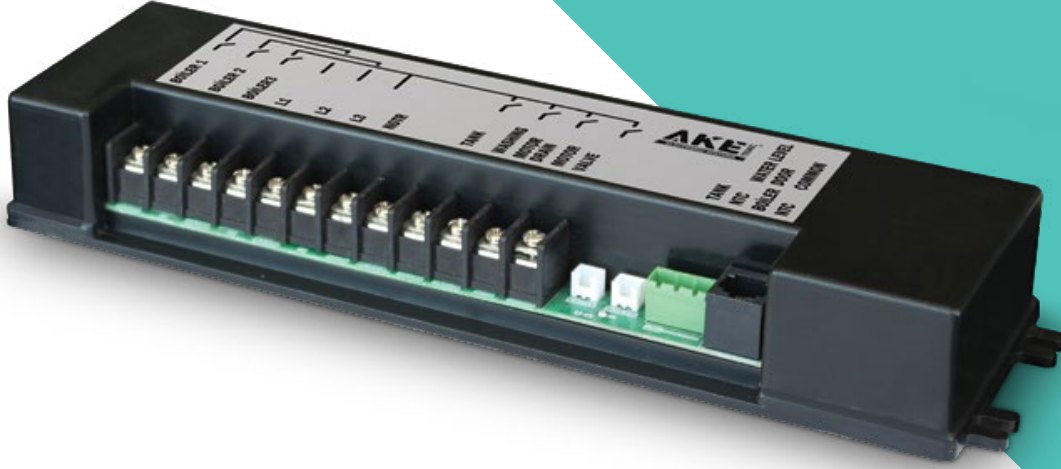

## Teknik Özellikler / Technical Specifications

- 3 adet ortak girişli röle çıkışı (Max: 220VAC-30A)
- 2 adet akım korumalı 220VAC çıkış (Max: 30A)
- 2 adet 220VAC çıkış (Max: 30A)
- 2 adet kuru kontak dijital giriş
- 2 adet NTC girişi
- 85-305VAC çalışma voltajı
- 3 units of common input relay output (Max: 220VAC-30A)
- 2 units of current protected 220VAC output (Max: 30A)
- 2 units of 220VAC output (Max: 30A)
- 4 units of digital input
- 2 units of NTC input
- 85-305VAC operating voltage

## Örnek uygulama alanları Application



Ürün Kodu  
Product Code

Ürün İsmi  
Product Name

AKE.R003.01.01

Bulaşık Yıkama Makinesi Röle Kartı (Premium) / Dishwasher I/O Unit (Premium)

Paket İçeriği  
Package Content

Montaj Aparatları  
Mounting Apparatus



Kullanma Kılavuzu  
User Manuals



Minimum Sipariş Miktarı  
Minimum Order quantity

12 Ad./Pcs

# AKE.R004.01.01

Plus

Bulaşık Yıkama Makinesi Röle Kartı  
Dishwasher I/O Unit

Bulaşık Yıkama Makinesi Kontrol Üniteleri | Controllers For Dishwashers



5 farklı yıkama program seçeneği  
5 different washing program options

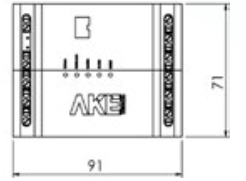
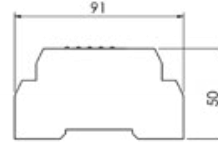
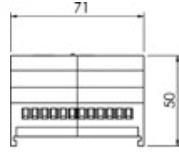

## Teknik Özellikler / Technical Specifications

- 8 adet çıkış kontağı (Max: 230VAC)
- Anahtarlama akımı (Max: 10A)
- 0-50 °C Çalışma sıcaklık aralığı
- 0-70 °C Saklama sıcaklığı
- IP 20 Koruma sınıfı
- Raya montaj bağlantı şekli
- 2 adet dijital giriş
- 2 adet NTC girişi
- 230VAC çalışma voltajı
- Yıkama Süreleri Ayar Aralığı (sn): T1: 30, T2: 60, T3: 90, T4: 120, T5: 180
- 180 saniye tahliye süresi

- 8 units output contact (Max: 230VAC)
- Switching current (Max: 10A)
- 0-50 °C Operation temperature range
- 0-70 °C Storage temperature
- IP 20 Protection class
- Rack mounting connection mode
- 2 units of digital input
- 2 units of NTC input
- 230VAC operating voltage
- Washing Time Setting Range (sec): T1: 30, T2: 60, T3: 90, T4: 120, T5: 180
- 180 second drain time

Ürün Kodu Product Code	Ürün İsmi Product Name
---------------------------	---------------------------

AKE.R004.01.01 Bulaşık Yıkama Makinesi Röle Kartı (Plus) / Dishwasher I/O Unit (Plus)

Paket İçeriği  
Package Content

Montaj Aparatları  
Mounting Apparatus



Kullanma Kılavuzu  
User Manuals



Minimum Sipariş Miktarı  
Minimum Order quantity

12 Ad./Pcs



5 farklı yıkama program seçeneği  
5 different washing program options

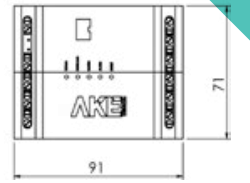
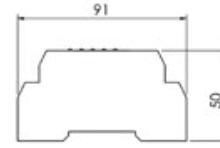
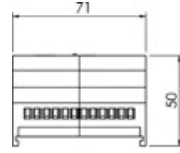

### Teknik Özellikler / Technical Specifications

- 6 adet çıkış kontağı (Max: 230VAC)
- Anahtarlama akımı (Max: 10A)
- 0-50 °C Çalışma sıcaklık aralığı
- 0-70 °C Saklama sıcaklığı
- IP 20 Koruma sınıfı
- Raya montaj bağlantı şekli
- 2 adet dijital giriş
- 2 adet NTC girişi
- 230VAC çalışma voltajı
- Yıkama Süreleri Ayar Aralığı (sn): T1: 30, T2: 60, T3: 90, T4: 120, T5: 180
- 180 saniye tahliye süresi
- 6 units output contact (Max: 230VAC)
- Switching current (Max: 10A)
- 0-50 °C Operation temperature range
- 0-70 °C Storage temperature
- IP 20 Protection class
- Rack mounting connection mode
- 2 units of digital input
- 2 units of NTC input
- 230VAC operating voltage
- Washing Time Setting Range (sec): T1: 30, T2: 60, T3: 90, T4: 120, T5: 180
- 180 second drain time

Ürün Kodu Product Code	Ürün İsmi Product Name
---------------------------	---------------------------

AKE.R004.02.01 Bulaşık Yıkama Makinesi Röle Kartı / Dishwasher I/O Unit

Paket İçeriği  
Package Content

Montaj Aparatları  
Mounting Apparatus ✓

Kullanma Kılavuzu  
User Manuals ✓

Minimum Sipariş Miktarı  
Minimum Order quantity

12 Ad./Pcs

# AKE.ZR001.01.01

Bulaşık Yıkama Makinesi Kontrol Üniteleri | Controllers For Dishwashers

## Komitatörlü Bulaşık Yıkama Makinesi Kontrol Ünitesi

### Dishwasher Controller With Manual Switch



5 farklı yıkama program seçeneği  
5 different washing program options

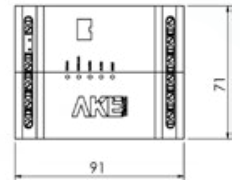
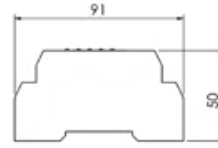
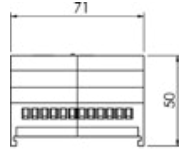

## Teknik Özellikler / Technical Specifications

- 6 adet çıkış kontağı (Max: 230VAC)
  - Anahtarlama akımı (Max: 10A)
  - 0-50 °C Çalışma sıcaklık aralığı
  - 0-70 °C Saklama sıcaklığı
  - IP 20 Koruma sınıfı
  - Raya montaj bağlantı şekli
  - 2 adet dijital giriş
  - 2 adet NTC girişi
  - 230VAC çalışma voltajı
  - Yıkama Süreleri Ayar Aralığı (sn): T1: 30, T2: 60, T3: 90, T4: 120, T5: 180
  - 180 saniye tahliye süresi
- 6 units output contact (Max: 230VAC)
  - Switching current (Max: 10A)
  - 0-50 °C Operation temperature range
  - 0-70 °C Storage temperature
  - IP 20 Protection class
  - Rack mounting connection mode
  - 2 units of digital input
  - 2 units of NTC input
  - 230VAC operating voltage
  - Washing Time Setting Range (sec): T1: 30, T2: 60, T3: 90, T4: 120, T5: 180
  - 180 second drain time

Ürün Kodu Product Code	Ürün İsmi Product Name
AKE.ZR001.01.01	Komitatörlü Bulaşık Yıkama Makinesi Kontrol Ünitesi Dishwasher Controller with manuel switc

Paket İçeriği  
Package Content

Montaj Aparatları  
Mounting Apparatus



Kullanma Kılavuzu  
User Manuals



Minimum Sipariş Miktarı  
Minimum Order quantity

12 Ad./Pcs



5 farklı yıkama program seçeneği  
5 different washing program options

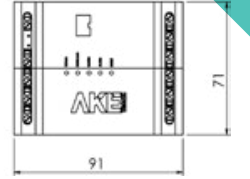
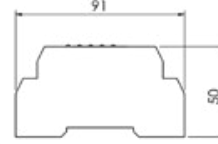
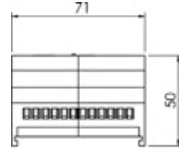

## Teknik Özellikler / Technical Specifications

- 4 adet çıkış kontağı (Max: 230VAC)
- Anahtarlama akımı (Max: 10A)
- 0-50 °C Çalışma sıcaklık aralığı
- 0-70 °C Saklama sıcaklığı
- IP 20 Koruma sınıfı
- Raya montaj bağlantı şekli
- 230VAC çalışma voltajı
- Yıkama Süreleri Ayar Aralığı (sn): T1: 30, T2: 60, T3: 90, T4: 120, T5: 180
- 180 saniye tahliye süresi
- 4 units output contact (Max: 230VAC)
- Switching current (Max: 10A)
- 0-50 °C Operation temperature range
- 0-70 °C Storage temperature
- IP 20 Protection class
- Rack mounting connection mode
- 230VAC operating voltage
- Washing Time Setting Range (sec): T1: 30, T2: 60, T3: 90, T4: 120, T5: 180
- 180 second drain time

**Ürün Kodu**  
**Product Code**

**Ürün İsmi**  
**Product Name**

AKE.ZR001.02.01 Bulaşık makinası zaman rölesi / Dishwasher time relay

**Paket İçeriği**  
**Package Content**

Montaj Aparatları  
Mounting Apparatus



Kullanma Kılavuzu  
User Manuals



Minimum Sipariş Miktarı  
Minimum Order quantity

12 Ad./Pcs

# AKE.ZR002.01.01

Bulařık Yıkama Makinesi Kontrol Üniteleri | Controllers For Dishwashers

## Yıkama Durulama Zaman Rölesi Washing Rinsing Time Relay



5 farklı yıkama program seçeneęi  
5 different washing program options

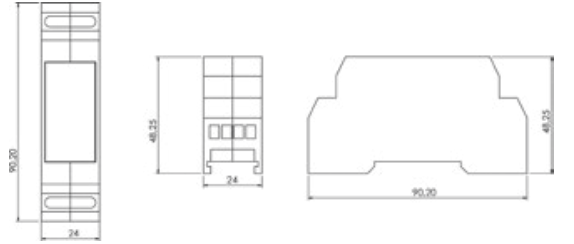

### Teknik Özellikler / Technical Specifications

- 3 adet çıkış kontaęı (Max: 230VAC)
- Raya montaj bağlantı şekli
- 230VAC çalışma voltajı
- Yıkama Süreleri Ayar Aralığı (sn):  
T1: 30, T2: 60, T3: 90, T4: 120, T5: 180
- Yıkama Çıkışı 220VAC-10A
- Durulama Çıkışı 220VAC-10A
- 3 units output contact (Max: 230VAC)
- Rack mounting connection mode
- 230VAC operating voltage
- Washing Time Setting Range (sec):  
T1: 30, T2: 60, T3: 90, T4: 120, T5: 180
- Washing Output 220VAC-10A
- Rinsing Output 220VAC-10A

Ürün Kodu  
Product Code

Ürün İsmi  
Product Name

AKE.ZR002.01.01 Yıkama Durulama Zaman Rölesi/ Washing Rinsing Time Relay

Paket İçerięi  
Package Content

Montaj Aparatları  
Mounting Apparatus



Kullanma Kılavuzu  
User Manuals



Minimum Sipariş Miktarı  
Minimum Order quantity

12 Ad./Pcs

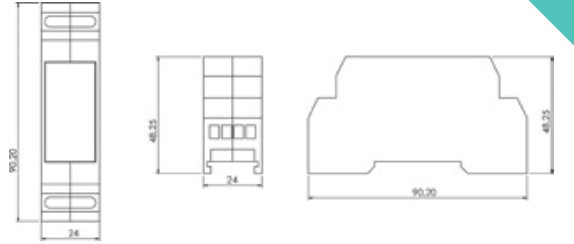

## Teknik Özellikler / Technical Specifications

- Çalışma gerilimi 220VAC-12V-24V
- Çalışma frekansı 220VAC-12V-24V
- Kontak Çıkışı 1NC + 1NO (Max:10A)
- 0-360 sn ayarlanabilir zaman ayarı
- Raya montaj bağlantı şekli
- Operating voltage 220VAC-12V-24V
- Operating frequency 220VAC-12V-24V
- Contact Output 1NC + 1NO (Max:10A)
- 0-360 second adjustable time setting
- Rack mounting connection mode

Ürün Kodu Product Code	Ürün İsmi Product Name
---------------------------	---------------------------

AKE.ZR003.01.01 Bulaşık makinası zaman rölesi / Dishwasher time relay

Paket İçeriği  
Package Content

Montaj Aparatları  
Mounting Apparatus



Kullanma Kılavuzu  
User Manuals



Minimum Sipariş Miktarı  
Minimum Order quantity

12 Ad./Pcs



Diğer Ürünler  
Other Products

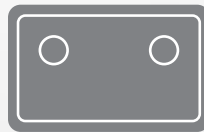
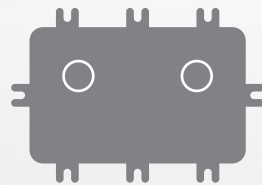

## Sıcak Banket Kontrol Ünitesi Hot Banquette Controller



7 Segment Ekran  
Segment Display



Dokunmatik Buton  
Touch Button

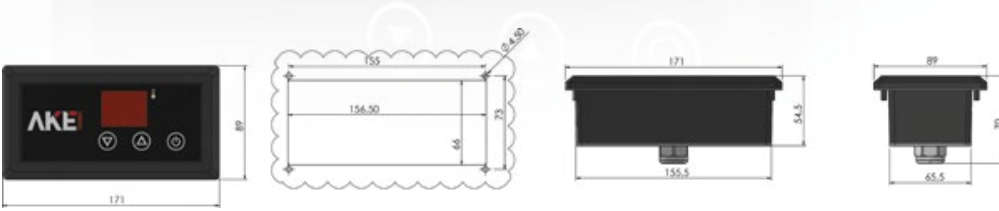

Zarif ve şık tasarımlı kontrol paneli  
Elegant and stylish control panel



Müşteriye özel tasarım  
Customer specific design



Değiştirilebilir görsel tasarım  
Changeable visual design



Sesli uyan sistemi  
Audible caution system



Darbeye dayanıklı, su geçirmez, ön panel  
Impact resistant, waterproof, front panel



Çalışma voltajı (220-240VAC)  
Operating voltage (220-240VAC)



Uyan aydınlatmaları  
Warning lights



LED Aydınlatmalı dokunmatik buton  
LED illuminated touch button

Montaj Sacı  
Assembly Sheet Metal

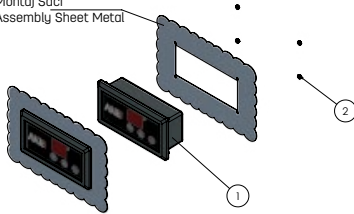

### Teknik Özellikler / Technical Specifications

- 1 adet 2 basamaklı 7 segment display
- 3 adet LED aydınlatmalı dokunmatik buton
- 1 adet 220VAC çıkış (Max:30A)
- 1 adet 220VAC çıkış (Max:10A)
- 1 adet termokupl girişi
- 1 unit of 2 digits 7 segment display
- 3 units of LED illuminated touch button
- 1 unit of 220VAC output (Max: 30A)
- 1 unit of 220VAC output (Max: 10A)
- 1 unit of thermocouple input

### Örnek uygulama alanları Application

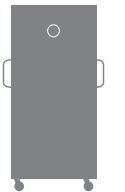

Ürün Kodu Product Code	Ürün İsmi Product Name
---------------------------	---------------------------

AKE.207.011.01.01 Sıcak banket arabası kontrol Ünitesi / Hot banquette trolley controller

Paket İçeriği  
Package Content

Montaj Aparatları  
Mounting Apparatus ✓

Kullanma Kılavuzu  
User Manuals ✓

Minimum Sipariş Miktarı  
Minimum Order quantity

12 Ad./Pcs

# AKE.107.001

Diğer Ürünler | Other Products

## Vakumlama Makinesi Kontrol Ünitesi Vacuum Machine Controller



7 Segment Ekran  
Segment Display



Donanımsal Buton  
Hardware Button



Zarif ve şık tasarımı kontrol paneli  
Elegant and stylish control panel



Müşteriye özel tasarım  
Customer specific design



Etiket görsel amaçlıdır.  
Paket içeriğinde yer almamaktadır.  
The label are for visual purposes.  
Not included in the package content.



Çalışma voltajı  
(220-240VAC)  
Operating voltage  
(220-240VAC)



Uyan aydınlatmaları  
Warning lights



Değiştirilebilir görsel tasarım  
Changeable visual design



Sesli uyan sistemi  
Audible caution system

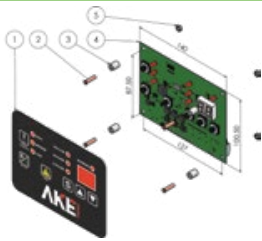

### Teknik Özellikler / Technical Specifications

- 1 adet 2 basamaklı 7 segment display
- 6 adet donanımsal buton
- 3 adet 220VAC çıkış (Max: 10A)
- 3 adet 220VAC çıkış (Max: 1A)
- 1 adet kuru kontak dijital giriş
- 1 unit of 2 digits 7 segment display
- 6 units of hardware button
- 3 units of 220VAC output (Max: 10A)
- 3 units of 220VAC output (Max: 1A)
- 1 unit of digital input

### Örnek uygulama alanları Application

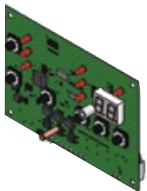

Ürün Kodu  
Product Code

Ürün İsmi  
Product Name

AKE.107.001.01.01 Vakumlama makinesi kontrol ünitesi / Vacuum machine controller

Paket İçeriği  
Package Content

Montaj Aparatları  
Mounting Apparatus ✓

Kullanma Kılavuzu  
User Manuals ✓

Kutu ve Etiket Dahil Değildir  
Box and Label Not Included ✗

Minimum Sipariş Miktarı  
Minimum Order Quantity 12 Ad./Pcs

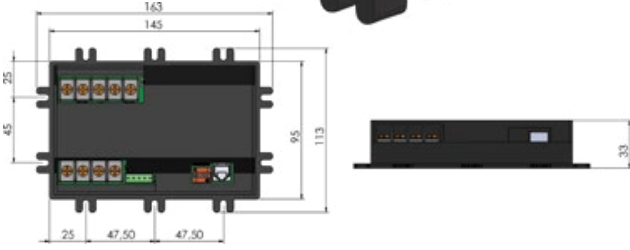
**Trifaze On-Off Kontrol Ünitesi**  
**Three-Phase On-Off Controller****Dokunmatik Buton**  
**Touch Button**

Zarif ve şık tasarımı kontrol paneli  
Elegant and stylish control panel



Müşteriye özel tasarım  
Customer specific design



Değiştirilebilir görsel tasarım  
Changeable visual design



Sesli uyarı sistemi  
Audible caution system



Darbeye dayanıklı, su geçirmez, ön panel  
Impact resistant, waterproof, front panel



Esnek çalışma voltajı (380-415VAC)  
Flexible operating voltage (380-415VAC)

**Teknik Özellikler / Technical Specifications**

- 1 adet RGB LED aydınlatmalı dokunmatik buton
- 1 adet 3 faz AC çıkış (Max: 30A)
- Her faz için akım koruma sensörü (Max: 30A)
- Ayarlanabilir akım koruma değeri
- Faz sırası kontrol
- 4 adet kuru kontak dijital giriş
- 1 unit of RGB LED illuminated touch button
- 1 unit 3-phase output (Max: 30A)
- Overcurrent protection for each phase (Max: 30A)
- Adjustable current protection rating
- Phase sequence control
- 4 units of digital input

**Örnek uygulama alanları**  
**Application**

Ürün Kodu Product Code	Ürün İsmi Product Name
---------------------------	---------------------------

AKE.200.001.01.01 Trifaze on-off kontrol ünitesi / Three-phase on-off controller

**Paket İçeriği**  
**Package Content**Montaj Aparatları  
Mounting Apparatus ✓Kullanma Kılavuzu  
User Manuals ✓Minimum Sipariş Miktarı  
Minimum Order quantity 12 Ad./Pcs

# AKE.200.002

Diğer Ürünler | Other Products

## Monofaze Start-Stop Kontrol Ünitesi Single-Phase Start-Stop Controller



Dokunmatik Buton  
Touch Button

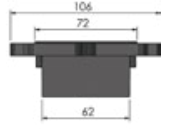
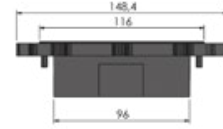
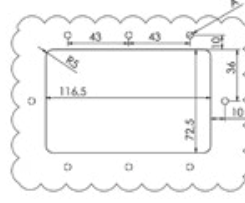
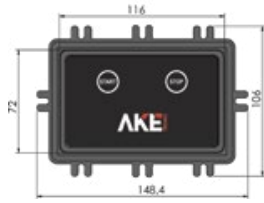

Zarif ve şık tasarımı kontrol paneli  
Elegant and stylish control panel



Müşteriye özel tasarım  
Customer specific design



Değiştirilebilir görsel tasarım  
Changeable visual design



Sesli uyarı sistemi  
Audible caution system



Darbeye dayanıklı, su geçirmez, ön panel  
Impact resistant, waterproof, front panel



Çalışma voltajı (220-240VAC)  
Operating voltage (220-240VAC)

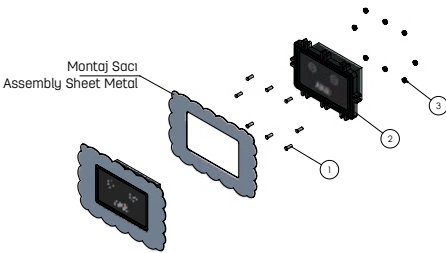

### Teknik Özellikler / Technical Specifications

- 2 adet LED aydınlatmalı dokunmatik buton
- 1 adet 220VAC çıkış (Max: 30A)
- Akım koruma sensörü (Max: 220V-20A)
- 2 adet kuru kontak dijital giriş
- 2 units of LED illuminated touch button
- 1 unit of 220VAC output (Max: 30A)
- Overcurrent protection (Max: 220V-20A)
- 2 units of digital input

### Örnek uygulama alanları Application

Ürün Kodu Product Code	Ürün İsmi Product Name
---------------------------	---------------------------

AKE.200.002.01.01 Monofaze start-stop kontrol ünitesi / Single-phase start-stop controller

Paket İçeriği  
Package Content

Montaj Aparatları  
Mounting Apparatus



Kullanma Kılavuzu  
User Manuals



Minimum Sipariş Miktarı  
Minimum Order quantity

12 Ad./Pcs

## Monofaze Start-Stop Kontrol Ünitesi Single-Phase Start-Stop Controller

Dokunmatik Buton  
Touch Button

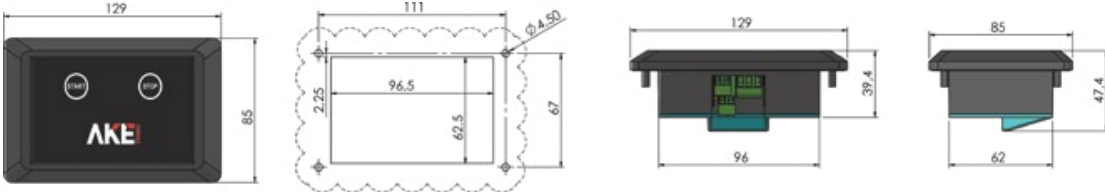

Zarif ve şık tasarımlı kontrol paneli  
Elegant and stylish control panel



Müşteriye özel tasarım  
Customer specific design



Değiştirilebilir görsel tasarım  
Changeable visual design



Sesli uyarı sistemi  
Audible caution system



Darbeye dayanıklı, su geçirmez, ön panel  
Impact resistant, waterproof, front panel



Çalışma voltajı (220-240VAC)  
Operating voltage (220-240VAC)

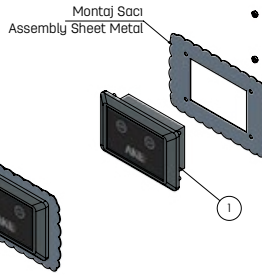

### Teknik Özellikler / Technical Specifications

- 2 adet LED aydınlatmalı dokunmatik buton
- 1 adet 220VAC çıkış (Max: 30A)
- Akım koruma sensörü (Max: 220V-20A)
- 2 adet kuru kontak dijital giriş
- 2 units of LED illuminated touch button
- 1 unit of 220VAC output (Max: 30A)
- Overcurrent protection (Max: 220V-20A)
- 2 units of digital input

### Örnek uygulama alanları Application

Ürün Kodu Product Code	Ürün İsmi Product Name
---------------------------	---------------------------

AKE.200.003.01.01 Monofaze start-stop kontrol ünitesi / Single-phase start-stop controller

Paket İçeriği  
Package Content

Montaj Aparatları  
Mounting Apparatus



Kullanma Kılavuzu  
User Manuals



Minimum Sipariş Miktarı  
Minimum Order quantity

12 Ad./Pcs

# AKE.200.004

Diğer Ürünler | Other Products

## Monofaze Start-Stop Kontrol Ünitesi Single-Phase Start-Stop Controller



Dokunmatik Buton  
Touch Button

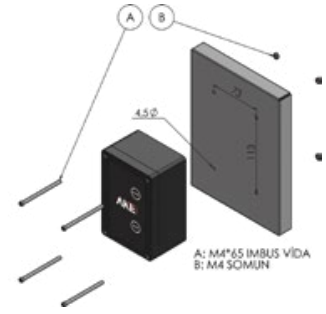
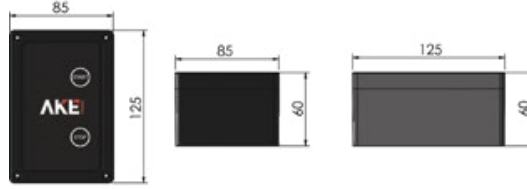

Zarif ve şık tasarımı kontrol paneli  
Elegant and stylish control panel



Müşteriye özel tasarım  
Customer specific design



Değiştirilebilir görsel tasarım  
Changeable visual design



Sesli uyarı sistemi  
Audible caution system



Darbeye dayanıklı, su geçirmez, ön panel  
Impact resistant, waterproof, front panel



Çalışma voltajı  
(220-240VAC)  
Operating voltage  
(220-240VAC)

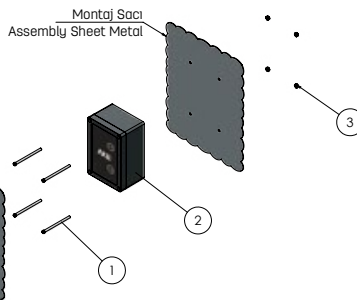

### Teknik Özellikler / Technical Specifications

- 2 adet LED aydınlatmalı dokunmatik buton
- 1 adet 220VAC çıkış (Max: 30A)
- Akım koruma sensörü (Max: 220V-20A)
- 2 adet kuru kontak dijital giriş
- 2 units of LED illuminated touch button
- 1 unit of 220VAC output (Max: 30A)
- Overcurrent protection (Max: 220V-20A)
- 2 units of digital input

### Örnek uygulama alanları Application

Ürün Kodu Product Code	Ürün İsmi Product Name
---------------------------	---------------------------

AKE.200.004.01.01 Monofaze start-stop kontrol ünitesi / Single-phase start-stop controller

Paket İçeriği  
Package Content

Montaj Aparatları  
Mounting Apparatus



Kullanma Kılavuzu  
User Manuals



Minimum Sipariş Miktarı  
Minimum Order quantity

12 Ad./Pcs

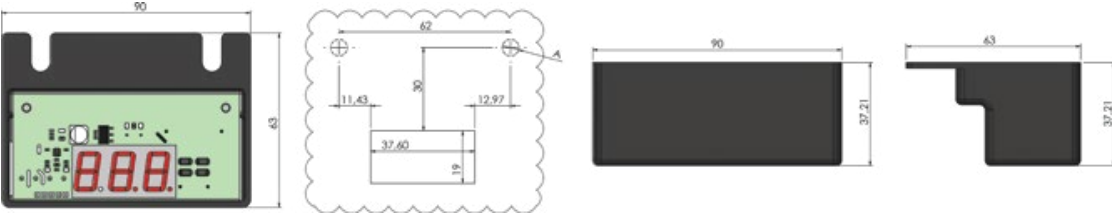
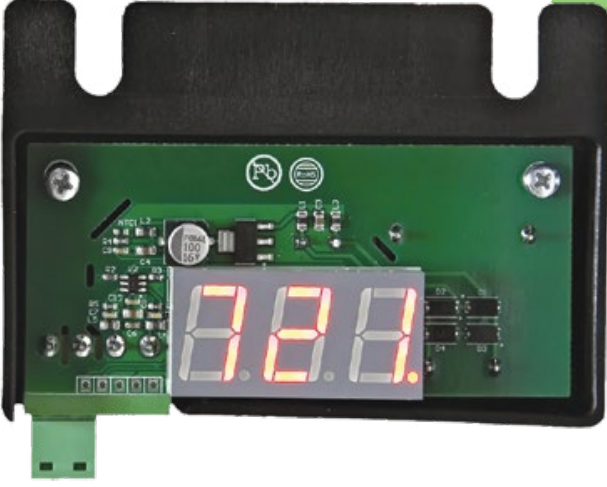
**Dijital Sıcaklık Göstergesi**  
**Digital Temperature Indicator****7** Segment Ekran  
Segment Display

Çalışma voltajı  
(220-240VAC)  
Operating voltage  
(220-240VAC)



Plastik montaj aparatı  
Plastic mounting bracket

**Teknik Özellikler / Technical Specifications**

- 1 adet 3 basamaklı 7 segment display
- 1 adet termokupl girişi
- 220-240VAC çalışma voltajı
- 1 unit of 3 digits 7 segment display
- 1 unit of thermocouple input
- 220-240VAC operating voltage

**Örnek uygulama alanları**  
**Application**

Ürün Kodu Product Code	Ürün İsmi Product Name
AKE.100.001.01.01	Dijital sıcaklık göstergesi/ Digital temperature indicator

Paket İçeriği  
Package Content

Montaj Aparatları  
Mounting Apparatus



Kullanma Kılavuzu  
User Manuals



Minimum Sipariş Miktarı  
Minimum Order quantity

12 Ad./Pcs

# AKE.100.002

Diğer Ürünler | Other Products

## 100A SCR Modülü 100A SCR Modul



7 Segment Ekran  
Segment Display

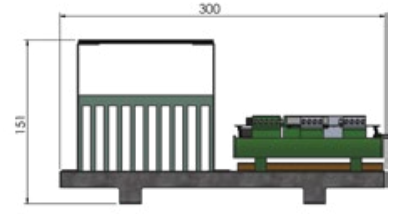
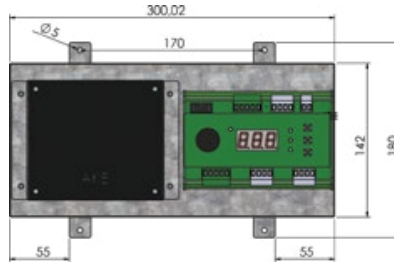
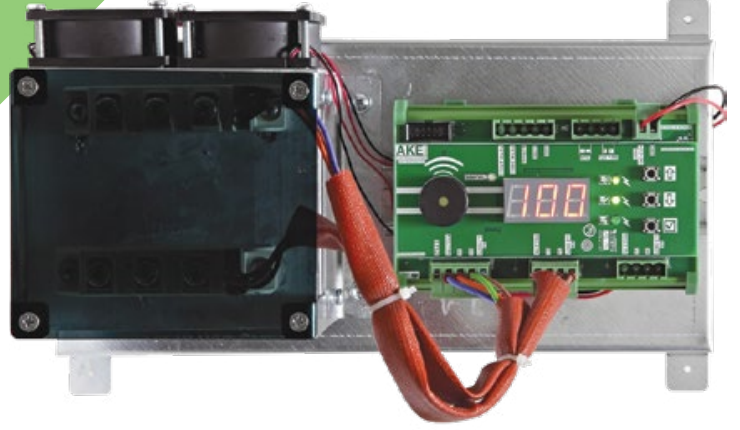

Esnek çalışma voltajı  
(85-400VAC)  
Flexible operating voltage  
(85-400VAC)



Aşırı sıcaklık koruması  
Overheat protection



Parametrelili çalışma düzeni  
Parameterized operation  
scheme

**100**  
Amper  
Ampere

## Teknik Özellikler / Technical Specifications

- 1 adet 3 basamaklı 7 segment display
- 12VDC çalışma voltajı
- Sesli uyarı sistemi
- 4 adet uyarı ledi
- 100 ampere kadar kontrol
- 4-20mA, 0-10V, on-off çalışma seçenekleri
- 3 faz veya tek faz kontrol edebilme özelliği
- 1 unit of 3 digits 7 segment display
- 12VDC operating voltage
- Alarm buzzer
- 4 units of warning led
- Control up to 100A
- 4-20mA, 0-10V, on-off options
- 3 phase or single phase control capability

## Örnek uygulama alanları Application

Ürün Kodu Product Code	Ürün İsmi Product Name
---------------------------	---------------------------

AKE.100.002.01.01 100A SCR modülü / 100A SCR modul

Paket İçeriği  
Package Content

Montaj Aparatları  
Mounting Apparatus



Kullanma Kılavuzu  
User Manuals



Minimum Sipariş Miktarı  
Minimum Order quantity

12 Ad./Pcs

## Tristör Modül Sürücü Ünitesi Thyristor Module Driver Board

7 Segment Ekran  
Segment Display 

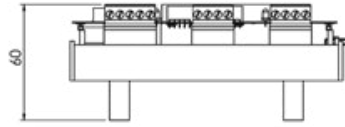
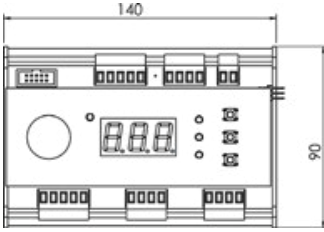

Esnek çalışma voltajı  
(85-400VAC)  
Flexible operating voltage  
(85-400VAC)



Aşırı sıcaklık koruması  
Overheat protection



Parametrelili çalışma düzeni  
Parameterized operation  
scheme



Sesli uyarı sistemi  
Audible caution  
system

### Teknik Özellikler / Technical Specifications

- Tüm tristör modülleri ile entegre çalışabilme
- 1 adet 3 basamaklı 7 segment display
- 12VDC çalışma voltajı
- 4 adet uyarı ledi
- 4-20mA, 0-10V, on-off çalışma seçenekleri
- 3 faz veya tek faz kontrol edebilme özelliği
- Integrated operation with all thyristor modules
- 1 unit of 3 digits 7 segment display
- 12VDC operating voltage
- 4 units of warning led
- 4-20mA, 0-10V, on-off operation options
- 3 phase or single phase control capability

### Örnek uygulama alanları Application

Ürün Kodu Product Code	Ürün İsmi Product Name
---------------------------	---------------------------

AKE.100.003.01.01 Tristör modül sürücü ünitesi / Thyristor module driver board

Paket İçeriği  
Package Content

Montaj Aparatları  
Mounting Apparatus ✓

Kullanma Kılavuzu  
User Manuals ✓

Minimum Sipariş Miktarı  
Minimum Order quantity 12 Ad./Pcs

# AKE.100.004

Diğer Ürünler | Other Products

## Analog Dimmer Kontrol Ünitesi Analog Dimmer Controller

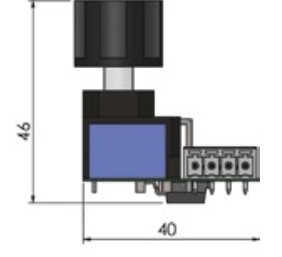
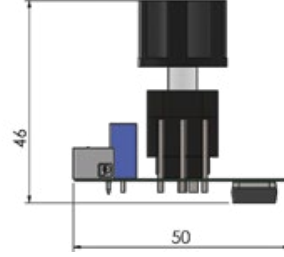
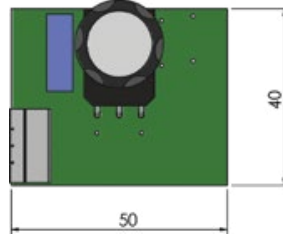

Esnek çalışma voltajı  
(110-220VAC)

Flexible operating voltage  
(110-220VAC)

### Teknik Özellikler / Technical Specifications

- 0,5 kW çıkış gücü
- 0,5 kW output power
- Plastik ön tutamaç
- Plastic front knob

### Örnek uygulama alanları Applicationv

Ürün Kodu Product Code	Ürün İsmi Product Name
AKE.100.004.01.01	Analog Dimmer Kontrol Ünitesi / Analog Dimmer Controller

Paket İçeriği  
Package Content

Montaj Aparatları  
Mounting Apparatus



Kullanma Kılavuzu  
User Manuals



Minimum Sipariş Miktarı  
Minimum Order quantity

12 Ad./Pcs

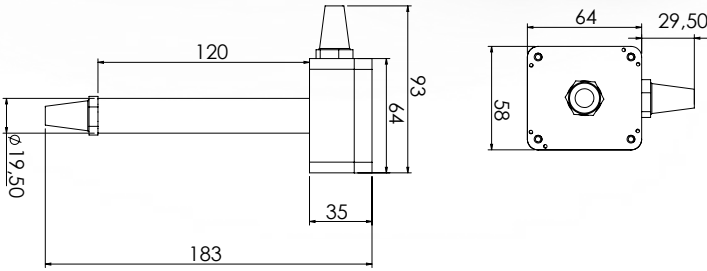
**MODBUS Nem ve Sıcaklık Sensörü**  
**MODBUS Humidity and**  
**Temperature Sensor****Teknik Özellikler / Technical Specifications**

- Bağıl Kesinlik Nem Sensörü :  $\pm 5\%$  RH (max), 0–90% RH
- Yüksek Hassasiyetli Sıcaklık Sensörü:  $\pm 1\text{ }^{\circ}\text{C}$  (max),  $-10$  to  $85\text{ }^{\circ}\text{C}$
- 2 adet 0-20mA / 4-20mA analog çıkış (Nem ve sıcaklık için)
- MODBUS üzerinden 2 adet NTC bağlayabilme
- 0 to 100% RH çalışma aralığı
- $-40$  to  $+125\text{ }^{\circ}\text{C}$  çalışma aralığı
- 12VDC çalışma voltajı
- Düşük Güç Tüketimi  
150  $\mu\text{A}$  aktif halde iken çekilen akım  
60 nA bekleme halinde iken çekilen akım
- Precision Relative Humidity Sensor:  $\pm 5\%$  RH (max), 0–90% RH
- High Accuracy Temperature Sensor:  $\pm 1\text{ }^{\circ}\text{C}$  (max),  $-10$  to  $85\text{ }^{\circ}\text{C}$
- 2 units of 0-20mA / 4-20mA analog output (For humidity and temperature)
- It is available to connect 2 units of NTC sensor via MODBUS
- 0 to 100% RH operating range
- $-40$  to  $+125\text{ }^{\circ}\text{C}$  operating range
- 12VDC operating voltage
- Low Power Consumption  
150  $\mu\text{A}$  active current aktif halde iken çekilen akım  
60 nA standby current bekleme halinde iken çekilen akım

**Örnek uygulama alanları**  
**Applicationv**

Ürün Kodu Product Code	Ürün İsmi Product Name
---------------------------	---------------------------

AKE.HTS.01 MODBUS Nem ve Sıcaklık Sensörü / MODBUS Humidity and Temperature Sensor

**Paket İçeriği**  
Package ContentKullanma Kılavuzu  
User ManualsMinimum Sipariş Miktarı  
Minimum Order quantity

12 Ad./Pcs



-09.8°C

24:15

AKE!

www.aketroniks.com

# Soğutma Grubu Kontrol Üniteleri Controllers for Refrigeration

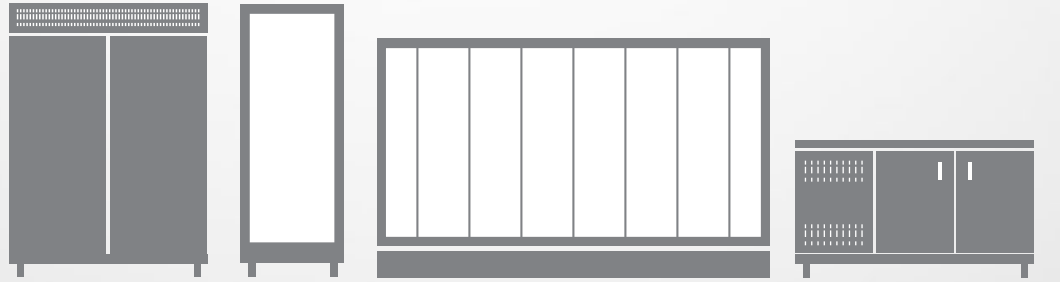



7 Segment Ekran  
Segment Display



Dokunmatik Buton  
Touch Button

# AKE.C207.012

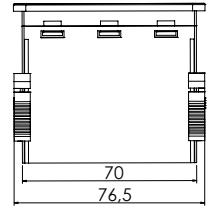
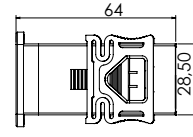
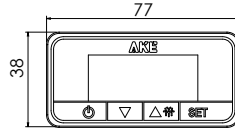

MONTAJ ŞEKLİ/ASSEMBLY TYPE

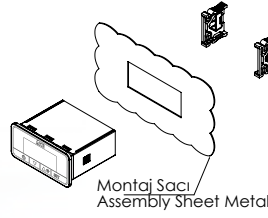

Montaj Sacı  
Assembly Sheet Metal

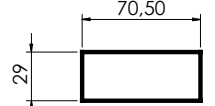
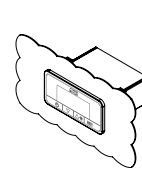

Montaj Kesim Ölçüsü  
Sheet Cutting Dimensions

MODEL MODEL	ÖZELLİKLER FEATURES	DİJİTAL ÇIKIŞLAR DIGITAL OUTPUTS	DİJİTAL GİRİŞLER DIGITAL INPUTS	PROBE PROBES	
AKE.C207.012.01.01	 4 x Dokunmatik Buton Standby Eritleme	7 Segment Display 47*22 4 x Touch Button Controller with standby defrost	1 adet 30A Kompresör	1 unit of 30A Compressor	1 adet 1 unit of NTC
AKE.C207.012.02.01	 4 x Dokunmatik Buton Kompresör, yardımcı röle çıkışı (Lamba, Alarm veya Evaporatör) yönetimi	7 Segment Display 47*22 4 x Touch Button Controller with Compressor and auxiliary relay outputs (Light, Alarm or Evap.)	2 adet 30 A Kompresör 10 A Yardımcı Çıkış	2 units of 30 A Compressor 10 A Aux	1 adet 1 unit of NTC
AKE.C207.012.03.01	 4 x Dokunmatik Buton Kompresör, eritleme ve evaporatör fan yönetimi	7 Segment Display 47*22 4 x Touch Button Controller with Compressor, defrost and evaporator fan management	3 adet 30 A Kompresör 16 A Eritleme 10 A Evaporatör Fan	3 units of 30 A Compressor 16 A Defrost 10 A Evaporator Fan	1 adet 1 unit of NTC
AKE.C207.012.04.01	 4 x Dokunmatik Buton Kompresör, eritleme ve evaporatör fan yönetimi	7 Segment Display 47*22 4 x Touch Button Controller with Compressor, defrost and evaporator fan management	3 adet 30 A Kompresör 16 A Eritleme 10 A Evaporatör Fan	3 units of 30 A Compressor 16 A Defrost 10 A Evaporator Fan	1 adet 1 unit of 2 adet 2 units of NTC



Sıcaklık verilerini  
depolayabilme  
Ability to store  
temperature



Nem sensörü  
Humidity sensor



Lokal izleme sistemi  
Local monitoring system



Müşteriye özel logo  
Customer specific logo



LED aydınlatmalı  
dokunmatik buton  
LED illuminated  
touch button



Enerji tasarruf sistemi  
Energy saving system



Çalışma voltajı (230VAC)  
Operating voltage (230VAC)



Eritleme yönetimi  
Defrost management



Zarif ve şık tasarımı  
kontrol paneli  
Elegant and stylish  
control panel



Darbeye dayanıklı, su  
geçirmez, ön panel  
Impact resistant,  
waterproof, front panel



Uyan aydınlatmaları  
Warning lights



Logo aydınlatması  
Logo illumination

Paket İçeriği  
Package Content

Montaj Aparatları  
Mounting Apparatus ✓

Kullanma Kılavuzu  
User Manuals ✓

Yardımcı Ekipmanlar  
Auxiliary Equipments ✗

Minimum Sipariş Miktarı  
Minimum Order Quantity 12 Ad./Pcs



7 Segment Ekran  
Segment Display



Dokunmatik Buton  
Touch Button



Gerçek Zaman Saati  
Real Time Clock



Kolay montaj ve servis  
Ease to mount ease to repair (EMER)

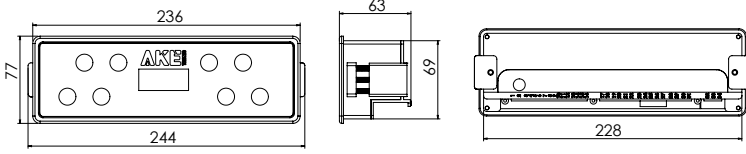

MONTAJ ŞEKLİ/ASSEMBLY TYPE

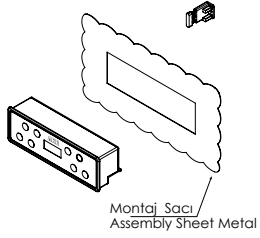

Montaj Sacı  
Assembly Sheet Metal

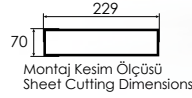

Montaj Kesim Ölçüsü  
Sheet Cutting Dimensions



# AKE.C207.504

MODEL MODEL	ÖZELLİKLER FEATURES	DİJİTAL ÇIKIŞLAR DIGITAL OUTPUTS	DİJİTAL GİRİŞLER DIGITAL INPUTS	PROBE PROBES	
AKE.C207504.01.01	7 Segment Display 47*22 8x Dokunmatik Buton Standby eritme, iç aydınlatma yönetimi	7 Segment Display 47*22 8x Touch Button Controller with standby defrost and cabinet light management	3 adet 30A Kompresör 16 A Eritme 10 A İç Aydınlatma 10 A Yardımcı Çıkış	3 units of 30A Compressor 16 A Cabinet light 10 A AUX	1 adet 1 unit 1 adet 1 unit of NTC
AKE.C207504.02.01	7 Segment Display 47*22 8x Dokunmatik Buton Kompresör, eritme, evaporator fan, iç aydınlatma yönetimi	7 Segment Display 47*22 8x Touch Button Controller with Compressor, defrost, evaporator fan and cabinet light management	4 adet 30 A Kompresör 16 A Eritme 10 A Evaporator Fan 10 A İç Aydınlatma	4 units of 30 A Compressor 16 A Defrost 10 A Evaporator Fan 10 A Cabinet light	1 adet 1 unit 2 adet 2 units of NTC
AKE.C207504.03.01	7 Segment Display 47*22 8x Dokunmatik Buton Kompresör, eritme, evaporator fan, iç aydınlatma selenoid valf, tahliye valfi ve cam fanı yönetimi	7 Segment Display 47*22 8x Touch Button Controller with Compressor, defrost, evaporator fan, cabinet light, selenoid valve, drainage valve and glass fan management	7 adet 30 A Kompresör 16 A Eritme 10 A Evaporator Fan 10 A İç Aydınlatma 10 A Selenoid Valfi 10 A Tahliye Valfi 10 A Cam Fani	7 units of 30 A Compressor 16 A Defrost 10 A Evaporator Fan 10 A Cabinet Light 10 A Selenoid Valve 10 A Drainage Valve 10 A Glass Fan	1 adet 1 unit 2 adet 2 units of NTC
AKE.C207505.01.01	7 Segment Display 47*22 8x Dokunmatik Buton Standby eritme, iç aydınlatma yönetimi	7 Segment Display 47*22 8x Touch Button Controller with standby defrost and cabinet light management	3 adet 30A Kompresör 10A İç Aydınlatma 10A Yardımcı Çıkış	3 units of 30A Compressor 10A Cabinet light 10A AUX	1 adet 1 unit 1 adet 1 unit of NTC
AKE.C207505.02.01	7 Segment Display 47*22 8x Dokunmatik Buton Kompresör, eritme, evaporator fan, iç aydınlatma yönetimi	7 Segment Display 47*22 8x Touch Button Controller with Compressor, defrost, evaporator fan and cabinet light management	4 adet 30 A Kompresör 16 A Eritme 10 A Evaporator Fan 10 A İç Aydınlatma	4 units of 30 A Compressor 16 A Defrost 10 A Evaporator Fan 10 A Cabinet light	1 adet 1 unit 2 adet 2 units of NTC
AKE.C207505.03.01	7 Segment Display 47*22 8x Dokunmatik Buton Kompresör, eritme, evaporator fan, iç aydınlatma selenoid valf, tahliye valfi ve cam fanı yönetimi	7 Segment Display 47*22 8x Touch Button Controller with Compressor, defrost, evaporator fan, cabinet light, selenoid valve, drainage valve and glass fan management	7 adet 30 A Kompresör 16 A Eritme 10 A Evaporator Fan 10 A İç Aydınlatma 10 A Selenoid Valfi 10 A Tahliye Valfi 10 A Cam Fani	7 units of 30 A Compressor 16 A Defrost 10 A Evaporator Fan 10 A Cabinet Light 10 A Selenoid Valve 10 A Drainage Valve 10 A Glass Fan	1 adet 1 unit 2 adet 2 units of NTC



Sıcaklık verilerini depolayabilme  
Ability to store temperature



Nem sensörü  
Humidity sensor



Lokal izleme sistemi  
Local monitoring system



Müşteriye özel logo  
Customer specific logo



LED aydınlatmalı dokunmatik buton  
LED illuminated touch button



Enerji tasarruf sistemi  
Energy saving system



Esnek çalışma voltajı  
(85-305VAC)  
Flexible operating voltage  
(85-305VAC)



Eritme yönetimi  
Defrost management



Sesli uyan sistemi  
Audible caution system



Darbeye dayanıklı, su geçirmez, ön panel  
Impact resistant, waterproof, front panel



Uyan aydınlatmaları  
Warning lights



Logo aydınlatması  
Logo illumination

Paket İçeriği  
Package Content

Montaj Aparatları  
Mounting Apparatus

Kullanma Kılavuzu  
User Manuals

Yardımcı Ekipmanlar  
Auxiliary Equipments

Minimum Sipariş Miktarı  
Minimum Order Quantity

12 Ad./Pcs



2.4" inç



64K Renkli TFT Ekran  
Color TFT Screen



Dokunmatik Buton  
Touch Button



Gerçek zaman saati  
Real time clock



Kolay montaj ve servis  
Ease to mount ease to repair (EMER)

# AKE.C324.007

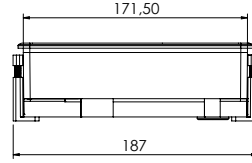
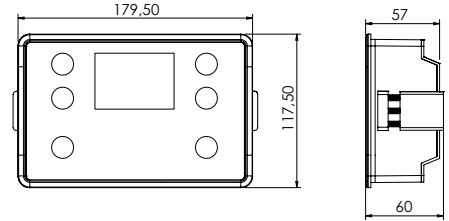

MONTAJ ŞEKLİ/ASSEMBLY TYPE

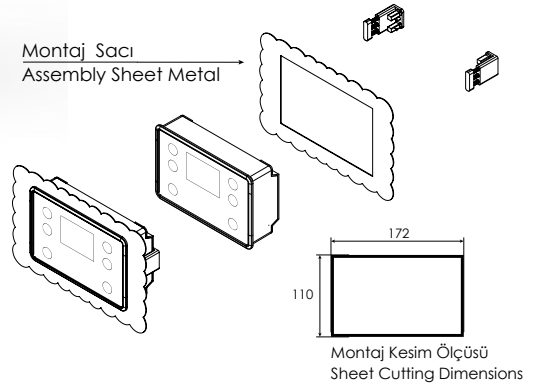

MODEL MODEL	ÖZELLİKLER FEATURES	DİJİTAL ÇIKIŞLAR DIGITAL OUTPUTS	DİJİTAL GİRİŞLER DIGITAL INPUTS	PROBE PROBES	FİYAT PRICE	
AKE.C324.00701.01	<p>2.4" TFT 6 x Dokunmatik Buton Standby eritme ve iç aydınlatma yönetimi</p>	<p>2.4" TFT 6 x Touch Button Controller with standby defrost and cabinet light management</p>	<p><b>2 adet</b> 30 A Kompresör 10 A İç Aydınlatma</p>	<p><b>2 units of</b> 30A Compressor 10A Cabinet light</p>	<p>1 adet 1 unit</p>	<p>1 adet 1 unit of NTC</p>
AKE.C324.00702.01	<p>2.4" TFT 6 x Dokunmatik Buton Kompresör, iç aydınlatma ve alarm yönetimi</p>	<p>2.4" TFT 6 x Touch Button Controller with Compressor, cabinet light and alarm management</p>	<p><b>3 adet</b> 30 A Kompresör 10 A Alarm 10 A İç Aydınlatma</p>	<p><b>3 units of</b> 30 A Compressor 10 A Alarm 10 A Cabinet light</p>	<p>1 adet 1 unit</p>	<p>1 adet 1 unit of NTC</p>
AKE.C324.00703.01	<p>2.4" TFT 6 x Dokunmatik Buton Kompresör, eritme, evaporator fan ve yardımcı röle çıkışı (Lamba, alarm) yönetimi</p>	<p>2.4" TFT 6 x Touch Button Controller with Compressor, defrost, evaporator fan and auxiliary relay output management (Light or Alarm)</p>	<p><b>4 adet</b> 30 A Kompresör 16 A Erıtme 10 A Evaporator Fan 10 A Yardımcı Çıkış</p>	<p><b>4 units of</b> 30 A Compressor 16 A Defrost 10 A Evaporator Fan 10 A Aux</p>	<p>2 adet 2 units</p>	<p>2 adet 2 units of NTC</p>
AKE.C324.00704.01	<p>2.4" TFT 6 x Dokunmatik Buton Kompresör, eritme, evaporator fan, iç aydınlatma ve alarm yönetimi</p>	<p>2.4" TFT 6 x Touch Button Controller with Compressor, defrost, evaporator fan, cabinet light and alarm management</p>	<p><b>5 adet</b> 30 A Kompresör 16 A Erıtme 10 A Evaporator Fan 10 A Alarm 10 A İç Aydınlatma</p>	<p><b>5 units of</b> 30 A Compressor 16 A Defrost 10 A Evaporator Fan 10 A Alarm 10 A Cabinet Light</p>	<p>2 adet 2 units</p>	<p>1 adet 2 units of NTC</p>



Sıcaklık verilerini  
depolayabilme  
Ability to store  
temperature



Nem sensörü  
Humidity sensor



Lokal izleme sistemi  
Local monitoring system



Müşteriye özel logo  
Customer specific logo



LED aydınlatmalı  
dokunmatik buton  
LED illuminated  
touch button



Enerji tasarruf sistemi  
Energy saving system



Esnek çalışma voltajı  
Flexible operating voltage



Eritme yönetimi  
Defrost management



Zarif ve şık tasarımı  
kontrol paneli  
Elegant and stylish  
control panel



Darbeye dayanıklı, su  
geçirmez, ön panel  
Impact resistant,  
waterproof, front panel



Uyan aydınlatmaları  
Warning lights



Logo aydınlatması  
Logo illumination

Paket içeriği  
Package Content

Montaj Aparatları  
Mounting Apparatus ✓

Kullanma Kılavuzu  
User Manuals ✓

Yardımcı Ekipmanlar  
Auxiliary Equipments ✗

Minimum Sipariş Miktarı  
Minimum Order Quantity 6 Ad./Pcs



4.3" inç  
Inch



64K

Renkli TFT Ekran  
Color TFT Screen



Dokunmatik Ekran  
Touch Screen



Gerçek zaman saati  
Real time clock



Kolay montaj ve servis  
Ease to mount ease to repair (EMER)



LOMOS Yönetici Cihaz  
LOMOS Master Device

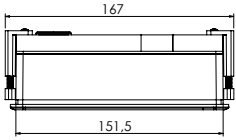
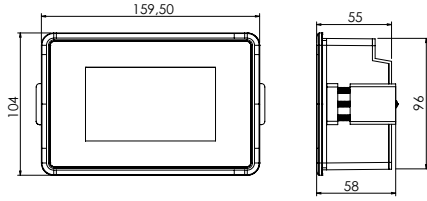

MONTAJ ŞEKLİ/ASSEMBLY TYPE

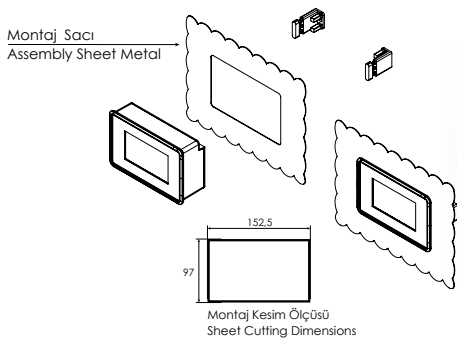

Uzaktan Kontrol/Remote Control

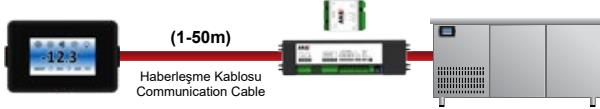

AKE.C430.001

Advanced Röle Kartı  
Advanced I/O Unit

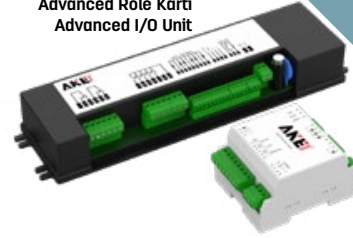

Basic Röle Kartı  
Basic I/O Unit

MODEL MODEL	ÖZELLİKLER FEATURES	DİJİTAL ÇIKIŞLAR DIGITAL OUTPUTS	DİJİTAL GİRİŞLER DIGITAL INPUTS	PROBE PROBES	FİYAT PRICE	
AKE.C430.001.01.01	4,3" Dokunmatik Ekran Standby eritme, iç aydınlatma and alarm yönetimi	4,3" Touch Screen Controller with standby defrost, cabinet light and alarm management	3 adet 30 A Kompresör 10 A İç Aydınlatma 10 A Alarm	3 units of 30 A Compressor 10 A Cabinet light 10 A Alarm	1 adet 1 unit	1 adet 1 unit of NTC
AKE.C430.001.02.01	4,3" Dokunmatik Ekran Kompresör, eritme, evaporator fan, yardımcı röle çıkışı (Lamba, alarm) yönetimi	4,3" Touch Screen Controller with compressor, defrost, evaporator fan and auxiliary relay output management (Light or Alarm)	4 adet 30 A Kompresör 16 A Eritme 10 A Evaporator Fan 10 A Yardımcı Çıkış	4 units of 30 A Compressor 16 A Defrost 10 A Evaporator Fan 10 A Aux	2 adet 2 units	3 adet 3 units of NTC
AKE.C430.001.03.01	4,3" Dokunmatik Ekran Kompresör, eritme, evaporator fan, iç aydınlatma ve alarm yönetimi	4,3" Touch Screen Controller with compressor, defrost, evaporator fan, cabinet light and alarm management	5 adet 30 A Kompresör 16 A Eritme 10 A Evaporator Fan 16 A İç Aydınlatma 10 A Alarm	5 units of 30 A Compressor 16 A Defrost 10 A Evaporator Fan 16 A Cabinet Light 10 A Alarm	2 adet 2 units	5 adet 5 units of NTC



Sıcaklık verilerini depolayabilme  
Ability to store temperature



Nem sensörü  
Humidity sensor



LOMOS Yönetici Cihaz  
LOMOS Master Device



Müşteriye özel logo  
Customer specific logo



LED aydınlatmalı dokunmatik buton  
LED illuminated touch button



Enerji tasarruf sistemi  
Energy saving system



Esnek çalışma voltajı  
(85-305VAC)  
Flexible operating voltage  
(85-305VAC)



Eritme yönetimi  
Defrost management



Sesli uyarı sistemi  
Audible caution system



Darbeye dayanıklı, su geçirmez, ön panel  
Impact resistant, waterproof, front panel



Uyarı aydınlatmaları  
Warning lights



Logo aydınlatması  
Logo illumination

Paket içeriği  
Package Content

Montaj Aparatları  
Mounting Apparatus



Kullanma Kılavuzu  
User Manuals



Yardımcı Ekipmanlar  
Auxiliary Equipments



Minimum Sipariş Miktarı  
Minimum Order Quantity

12 Ad./Pcs

7 Segment Ekran  
7 Segment DisplayDokunmatik Buton  
Touch ButtonGerçek Zaman Saati  
Real Time ClockEkran I/O kartı ile birlikte çalışmaktadır.  
The display unit can work with I/O unit.Kolay montaj ve servis  
Ease to mount ease to repair (EMER)

## AKE.C207502

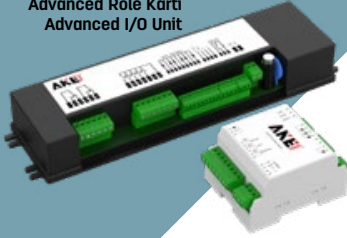
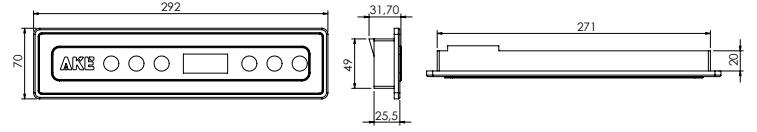
Advanced Röle Kart  
Advanced I/O UnitBasic Röle Kart  
Basic I/O UnitÖn yüzey montaj şekli  
Front-side assembly

MONTAJ ŞEKLİ/ASSEMBLY TYPE

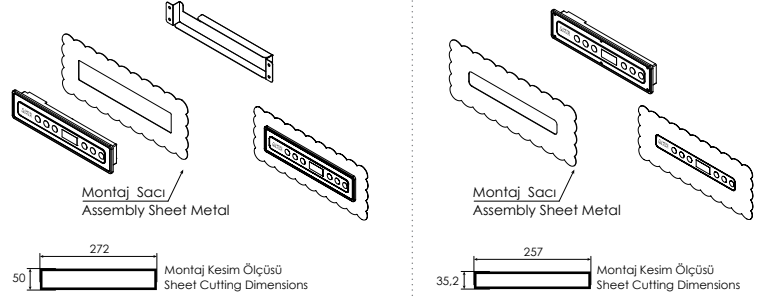
Arka yüzey montaj şekli  
Backside assembly

Uzaktan Kontrol/Remote Control

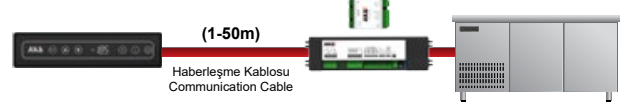

MODEL MODEL	ÖZELLİKLER FEATURES	DİJİTAL ÇIKIŞLAR DIGITAL OUTPUTS	DİJİTAL GİRİŞLER DIGITAL INPUTS	PROBE PROBES	
AKE.C207502	7 Segment Display 47*22 6 x Dokunmatik Buton HACCP Gerçek Zaman Saati Sesli Uyan Donanımı IP65 Koruma (Ön Panel)	7 Segment Display 47*22 6 x Touch Button HACCP Real Time Clock Internal Buzzer IP65 Protection (Front Face)			
AKE.C207502.01.01	7 Segment Display 47*22 6 x Dokunmatik Buton Standby ertme ve iç aydınlatma yönetimi	7 Segment Display 47*22 6 x Touch Button Controller with standby defrost and cabinet light management	2 adet 30 A Kompresör 10 A İç Aydınlatma	2 units of 30 A Compressor 10 A Cabinet light	1 adet 1 unit 1 adet 1 unit of NTC
AKE.C207502.02.01	7 Segment Display 47*22 6 x Dokunmatik Buton Standby ertme ve yardımcı çıkış (Lamba ve Alarm) yönetimi	7 Segment Display 47*22 6 x Touch Button Controller with standby defrost and auxiliary relay output management (Light or Alarm)	2 adet 30 A Kompresör 10 A Yardımcı Çıkış	2 units of 30 A Compressor 10 A Aux	2 adet 2 units 1 adet 1 unit of NTC
AKE.C207502.03.01	7 Segment Display 47*22 6 x Dokunmatik Buton Kompresör, ertme, evaporator fan, ve iç aydınlatma yönetimi	7 Segment Display 47*22 6 x Touch Button Controller with Compressor, defrost, evaporator fan and cabinet light management	4 adet 30 A Kompresör 16 A Eritme 10 A Evaporator Fan 10 A İç Aydınlatma	4 units of 30 A Compressor 16 A Defrost 10 A Evaporator Fan 10 A Cabinet light	1 adet 1 unit 2 adet 2 units of NTC
AKE.C207502.04.01	7 Segment Display 47*22 6 x Dokunmatik Buton Kompresör, ertme, evaporator fan, ve iç aydınlatma yönetimi	7 Segment Display 47*22 6 x Touch Button Controller with Compressor, defrost, evaporator fan and cabinet light management	4 adet 30 A Kompresör 16 A Eritme 10 A Evaporator Fan 10 A İç Aydınlatma	4 units of 30 A Compressor 16 A Defrost 10 A Evaporator Fan 10 A Cabinet light	2 adet 2 units 2 adet 2 units of NTC
AKE.C207502.05.01	7 Segment Display 47*22 6 x Dokunmatik Buton Kompresör, ertme, evaporator fan, kondenser fan, iç aydınlatma, alarm, yardımcı röle çıkış yönetimi	7 Segment Display 47*22 6 x Touch Button Controller with Compressor, defrost, evaporator fan, condenser fan, cabinet light, alarm and auxiliary relay output management	7 adet 30 A Kompresör 16 A Eritme 10 A Evaporator Fan 10 A Kondenser Fan 16 A İç Aydınlatma 10 A Alarm 10 A Yardımcı Çıkış	7 units of 30 A Compressor 16 A Defrost 10 A Evaporator Fan 10 A Condenser Fan 16 A Cabinet Light 10 A Alarm 10 A Aux	2 adet 2 units 6 adet 6 units of NTC

Sıcaklık verilerini depolayabilme  
Ability to store temperatureNem sensörü  
Humidity sensorLokal izleme sistemi  
Local monitoring systemMüşteriye özel logo  
Customer specific logoLED aydınlatmalı dokunmatik buton  
LED illuminated touch buttonEnerji tasarruf sistemi  
Energy saving systemEsnek çalışma voltajı  
Flexible operating voltageEritme yönetimi  
Defrost managementSesli uyan sistemi  
Audible caution systemDarbeye dayanıklı, su geçirmez, ön panel  
Impact resistant, waterproof, front panelUyan aydınlatmaları  
Warning lightsLogo aydınlatması  
Logo illuminationPaket içeriği  
Package ContentMontaj Aparatları  
Mounting Apparatus ✓Kullanma Kılavuzu  
User Manuals ✓Yardımcı Ekipmanlar  
Auxiliary Equipments ✗Minimum Sipariş Miktarı  
Minimum Order Quantity 6 Ad./Pcs



7 Segment Ekran  
Segment Display



Dokunmatik Buton  
Touch Button



Gerçek Zaman Saati  
Real Time Clock



Ekran I/O kartı ile birlikte çalışmaktadır.  
The display unit can work with I/O unit.



Kolay montaj ve servis  
Ease to mount ease to repair (EMER)

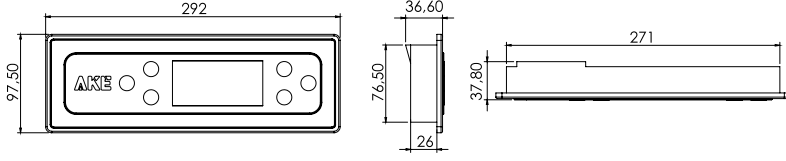

# AKE.C207.503

Ön yüzey montaj şekli  
Front-side assembly

MONTAJ ŞEKLİ/ASSEMBLY TYPE

Arka yüzey montaj şekli  
Backside assembly

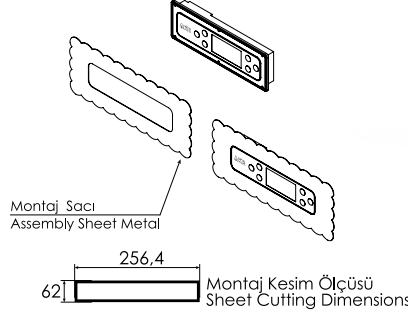
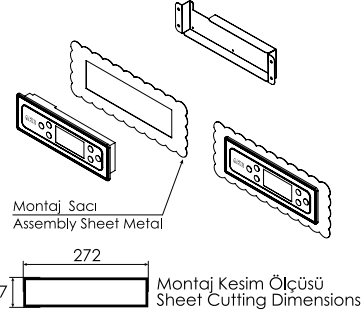

Advanced Röle Kart  
Advanced I/O Unit

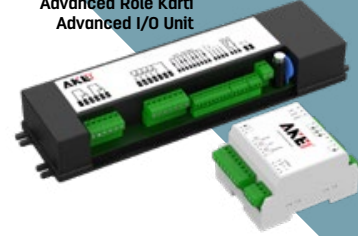

Basic Röle Kart  
Basic I/O Unit



Uzaktan Kontrol/Remote Control

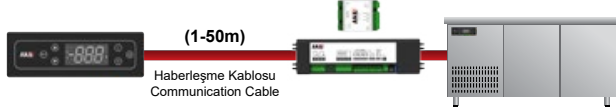

MODEL MODEL	ÖZELLİKLER FEATURES	DİJİTAL ÇIKIŞLAR DIGITAL OUTPUTS	DİJİTAL GİRİŞLER DIGITAL INPUTS	PROBE PROBES	FİYAT PRICE	
AKEC207.503	7 Segment Display 45*90 6 x Dokunmatik Buton HACCP Gerçek Zaman Saati Sesli Uyan Donanımı IP65 Koruma (Ön Panel)	7 Segment Display 45*90 6 x Touch Button HACCP Real Time Clock Internal Buzzer IP65 Protection (Front Face)				
AKEC207.503.01.01	7 Segment Display 45*90 6 x Dokunmatik Buton Standby ertme ve iç aydınlatma yönetimi	7 Segment Display 45*90 6 x Touch button controller with standby defrost and cabinet light management	<b>2 adet</b> 30 A Kompresör 10 A İç Aydınlatma	<b>2 units of</b> 30 A Compressor 10 A Cabinet light	1 adet 1 unit	1 adet 1 unit of NTC
AKEC207.503.02.01	7 Segment Display 45*90 6 x Dokunmatik Buton Standby ertme, alarm ve iç aydınlatma yönetimi	7 Segment Display 45*90 6 x Touch button controller with standby defrost, alarm, cabinet light management	<b>3 adet</b> 30 A Kompresör 16 A Alarm 10 A İç Aydınlatma	<b>3 units of</b> 30 A Compressor 10 A Alarm 10 A Cabinet Light	1 adet 1 units	1 adet 1 unit of NTC
AKEC207.503.03.01	7 Segment Display 45*90 6 x Dokunmatik Buton Kompresör, ertme, evaporator fan ve iç aydınlatma, yönetimi	7 Segment Display 45*90 6 x Touch button controller with compressor, defrost, evaporator fan and cabinet light management	<b>4 adet</b> 30 A Kompresör 16 A Eritme 10 A Evaporator Fan 10 A İç Aydınlatma	<b>4 units of</b> 30 A Compressor 16 A Defrost 10 A Evaporator Fan 10 A Cabinet light	1 adet 1 unit	2 adet 2 units of NTC
AKEC207.503.04.01	7 Segment Display 45*90 6 x Dokunmatik Buton Kompresör, ertme, evaporator fan, kondenser fan, iç aydınlatma, alarm, yardımcı röle çıkış yönetimi	7 Segment Display 45*90 6 x Touch button controller with compressor, defrost, evaporator fan, condenser fan, cabinet light, alarm and auxiliary relay output management	<b>7 adet</b> 30 A Kompresör 16 A Eritme 10 A Evaporator Fan 10 A Kondenser Fan 16 A İç Aydınlatma 10 A Alarm 10 A Yardımcı Çıkış	<b>7 units of</b> 30 A Compressor 16 A Defrost 10 A Evaporator Fan 10 A Condenser Fan 16 A Cabinet Light 10 A Alarm 10 A Aux	2 adet 2 units	6 adet 6 units of NTC



Sıcaklık verilerini depolayabilme  
Ability to store temperature



Nem sensörü  
Humidity sensor



Lokal izleme sistemi  
Local monitoring system



Müşteriye özel logo  
Customer specific logo



LED aydınlatmalı dokunmatik buton  
LED illuminated touch button



Enerji tasarruf sistemi  
Energy saving system



Esnek çalışma voltajı  
Flexible operating voltage



Eritme yönetimi  
Defrost management



Sesli uyan sistemi  
Audible caution system



Darbeye dayanıklı, su geçirmez, ön panel  
Impact resistant, waterproof, front panel



Uyan aydınlatmaları  
Warning lights



Logo aydınlatması  
Logo illumination

Paket içeriği  
Package Content

Montaj Aparatları  
Mounting Apparatus ✓

Kullanma Kılavuzu  
User Manuals ✓

Yardımcı Ekipmanlar  
Auxiliary Equipments ✗

Minimum Sipariş Miktarı  
Minimum Order Quantity 6 Ad./Pcs



4.3" inç



64K Renkli TFT Ekran

Color TFT Screen



Gerçek Zaman Saati  
Real Time Clock



Ekran I/O kartı ile birlikte çalışmaktadır.  
The display unit can work with I/O unit.



USB üzerinden veri aktarabilme  
Data transfer feature via USB



Kolay montaj ve servis  
Ease to mount ease to repair (EMER)

# AKE.C343.503



Advanced Röle Kart  
Advanced I/O Unit

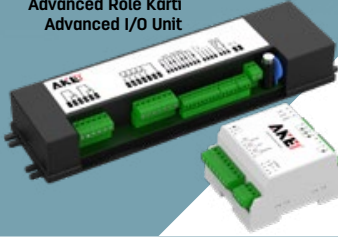

Basic Röle Kart  
Basic I/O Unit

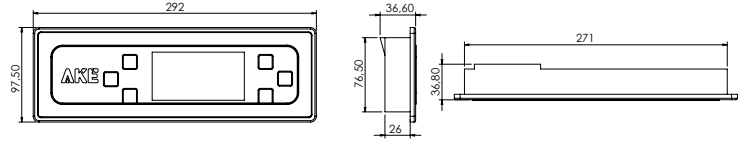

Ön yüzey montaj şekli  
Front-side assembly

MONTAJ ŞEKLİ/ASSEMBLY TYPE

Arka yüzey montaj şekli  
Backside assembly

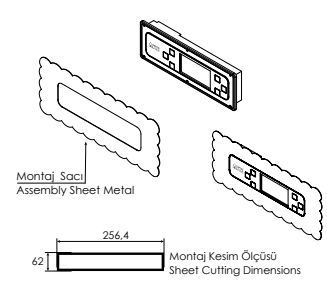
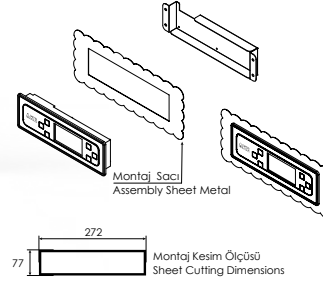

Uzaktan Kontrol/Remote Control



MODEL MODEL	ÖZELLİKLER FEATURES	DİJİTAL ÇIKIŞLAR DIGITAL OUTPUTS	DİJİTAL GİRİŞLER DIGITAL INPUTS	PROBE PROBES	
AKE.C343.503	4.3" TFT 6 x Dokunmatik Buton HACCP Gerçek Zaman Saati Sesli Uyan Donanımı IP65 Koruma (Ön Panel)	4.3" TFT 6 x Touch Button HACCP Real Time Clock Internal Buzzer IP65 Protection (Front Face)			
AKE.C343.503.01.01	4.3" TFT 6 x Dokunmatik Buton Standby eritme ve iç aydınlatma ve alarm yönetimi	4.3" TFT, 6 x Touch Button Controller with standby defrost, cabinet light and alarm management	3 adet 30 A Kompresör 10 A İç Aydınlatma 10 A Alarm	3 units of 30 A Compressor 10 A Cabinet light 10 A Alarm	1 adet 1 unit 1 adet 1 unit of NTC
AKE.C343.503.02.01	4.3" TFT 6 x Dokunmatik Buton Kompresör, eritme, evaporator fan, iç aydınlatma ve alarm yönetimi	4.3" TFT, 6 x Touch Button Controller with Compressor, defrost, evaporator fan, cabinet light and alarm management	5 adet 30 A Kompresör 16 A Eritme 10 A Evaporator Fan 10 A İç Aydınlatma 10 A Alarm	5 units of 30 A Compressor 16 A Defrost 10 A Evaporator Fan 16 A Cabinet Light 10 A Alarm	2 adet 2 units 2 adet 2 units of NTC
AKE.C343.503.03.01	4.3" TFT 6 x Dokunmatik Buton Kompresör, eritme, evaporator fan, kondenser fan, iç aydınlatma ve alarm, yönetimi	4.3" TFT, 6 x Touch Button Controller with Compressor, defrost, evaporator fan, condenser fan, cabinet light and alarm management	6 adet 30 A Kompresör 16 A Eritme 10 A Evaporator Fan 10 A Kondenser Fan 16 A İç Aydınlatma 10 A Alarm	6 units of 30 A Compressor 16 A Defrost 10 A Evaporator Fan 10 A Condenser Fan 16 A Cabinet Light 10 A Alarm	2 adet 2 units 3 adet 3 units of NTC
AKE.C343.503.04.01	4.3" TFT 6 x Dokunmatik Buton Kompresör, eritme, evaporator fan, kondenser fan, iç aydınlatma, alarm ve yardımcı röle çıkış yönetimi	4.3" TFT, 6 x Touch Button Controller with Compressor, defrost, evaporator fan, condenser fan, cabinet light, alarm and auxiliary relay output management	7 adet 30 A Kompresör 16 A Eritme 10 A Evaporator Fan 10 A Kondenser Fan 16 A İç Aydınlatma 10 A Alarm 10 A Yardımcı Çıkış	7 units of 30 A Compressor 16 A Defrost 10 A Evaporator Fan 10 A Condenser Fan 16 A Cabinet Light 10 A Alarm 10 A Aux	2 adet 2 units 6 adet 6 units of NTC



Sıcaklık verilerini depolayabilme  
Ability to store temperature



Nem sensörü  
Humidity sensor



Lokal izleme sistemi  
Local monitoring system



Müşteriye özel logo  
Customer specific logo



LED aydınlatmalı dokunmatik buton  
LED illuminated touch button



Enerji tasarruf sistemi  
Energy saving system



Esnek çalışma voltajı  
Flexible operating voltage



Eritme yönetimi  
Defrost management



Sesli uyan sistemi  
Audible caution system



Darbeye dayanıklı, su geçirmez, ön panel  
Impact resistant, waterproof, front panel



Uyan aydınlatmaları  
Warning lights



Logo aydınlatması  
Logo illumination

Paket İçeriği  
Package Content

Montaj Aparatları  
Mounting Apparatus



Kullanma Kılavuzu  
User Manuals



Yardımcı Ekipmanlar  
Auxiliary Equipments



Minimum Sipariş Miktarı  
Minimum Order Quantity 6 Ad./Pcs

7" inç  
Inch64K Renkli TFT Ekran  
Color TFT ScreenDokunmatik Ekran  
Touch ScreenEkran I/O kartı ile birlikte çalışmaktadır.  
The display unit can work with I/O unit.Kolay montaj ve servis  
Ease to mount ease to repair (EMER)LOMOS Yönetici Cihaz  
LOMOS Master DeviceGerçek zaman saati  
Real time clock

AKE.C470.506

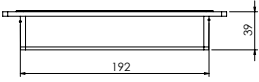
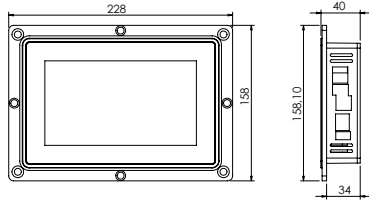

MONTAJ ŞEKLİ/ASSEMBLY TYPE

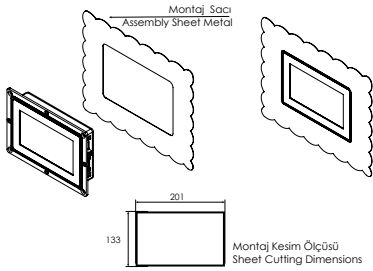
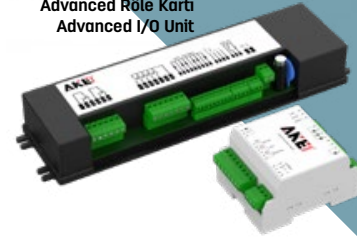
Advanced Röle Kartı  
Advanced I/O UnitBasic Röle Kartı  
Basic I/O Unit

Uzaktan Kontrol/Remote Control

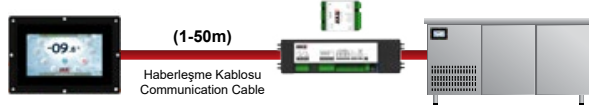

MODEL MODEL	ÖZELLİKLER FEATURES	DİJİTAL ÇIKIŞLAR DIGITAL OUTPUTS	DİJİTAL GİRİŞLER DIGITAL INPUTS	PROBE PROBES
AKEC470.506	7" Dokunmatik Ekran HACCP Gerçek Zaman Saati Sesli Uyan Donanımı IP65 Koruma (Ön Panel)	7" Touch Screen HACCP Real Time Clock Internal Buzzer IP65 Protection (Front Face)		
AKEC470.506.01.01	7" Dokunmatik Ekran Kompresör, eritme, evaporator fan, iç aydınlatma ve alarm yönetimi	7" Touch Screen Controller with Compressor, defrost, evaporator fan, cabinet light and alarm management	5 adet 30 A Kompresör 16 A Eritme 10 A Evaporator Fan 10 A İç Aydınlatma 10 A Alarm	5 units of 30 A Compressor 16 A Defrost 10 A Evaporator Fan 16 A Cabinet Light 10 A Alarm
AKEC470.506.02.01	7" Dokunmatik Ekran Kompresör, eritme, evaporator fan,kondenser fan, iç aydınlatma ve alarm, yönetimi	7" Touch Screen Controller with Compressor, defrost, evaporator fan, condenser fan, cabinet light and alarm management	6 adet 30 A Kompresör 16 A Eritme 10 A Evaporator Fan 10 A Kondenser Fan 16 A İç Aydınlatma 10 A Alarm	6 units of 30 A Compressor 16 A Defrost 10 A Evaporator Fan 10 A Condenser Fan 16 A Cabinet Light 10 A Alarm
AKEC470.506.03.01	7" Dokunmatik Ekran Kompresör, eritme, evaporator fan,kondenser fan, iç aydınlatma, alarm ve yardımcı röle çıkış yönetimi	7" Touch Screen Controller with Compressor, defrost, evaporator fan, condenser fan, cabinet light, alarm and auxiliary relay output management	7 adet 30 A Kompresör 16 A Eritme 10 A Evaporator Fan 10 A Kondenser Fan 16 A İç Aydınlatma 10 A Alarm 10 A Yardımcı Çıkış	7 units of 30 A Compressor 16 A Defrost 10 A Evaporator Fan 10 A Condenser Fan 16 A Cabinet Light 10 A Alarm 10 A Aux

Sıcaklık verilerini  
depolayabilme  
Ability to store  
temperatureNem sensörü  
Humidity sensorLOMOS Yönetici Cihaz  
LOMOS Master DeviceMüşteriye özel logo  
Customer specific logoLED aydınlatmalı  
dokunmatik buton  
LED illuminated  
touch buttonEneji tasarruf sistemi  
Energy saving systemEsnek çalışma voltajı  
Flexible operating voltageEritme yönetimi  
Defrost managementSesli uyan sistemi  
Audible caution  
systemDarbeye dayanıklı, su  
geçirmez, ön panel  
Impact resistant,  
waterproof, front panelUyan aydınlatmaları  
Warning lightsLogo aydınlatması  
Logo illuminationPaket içeriği  
Package ContentMontaj Aparatları  
Mounting ApparatusKullanma Kılavuzu  
User ManualsYardımcı Ekipmanlar  
Auxiliary EquipmentsMinimum Sipariş Miktarı  
Minimum Order Quantity

6 Ad./Pcs



4.3" inç

64K Renkli TFT Ekran  
Color TFT ScreenGerçek Zaman Saati  
Real Time ClockEkran I/O kartı ile birlikte çalışmaktadır.  
The display unit can work with I/O unit.USB üzerinden veri aktarılabilir  
Data transfer feature via USBKolay montaj ve servis  
Ease to mount ease to repair (EMER)

## AKE.C470.508

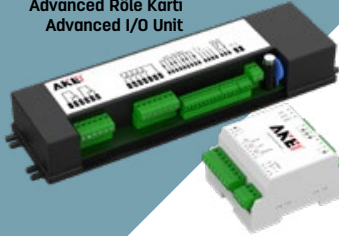
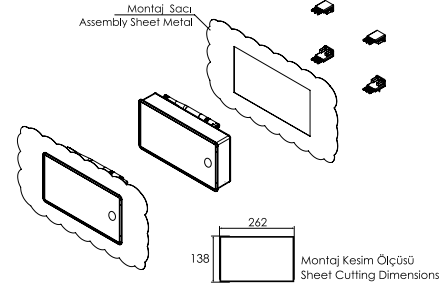
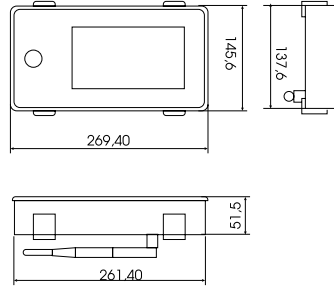
Advanced Röle Kart  
Advanced I/O UnitBasic Röle Kart  
Basic I/O Unit

Uzaktan Kontrol/Remote Control

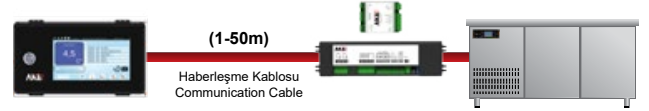

MODEL MODEL	ÖZELLİKLER FEATURES	DİJİTAL ÇIKIŞLAR DIGITAL OUTPUTS	DİJİTAL GİRİŞLER DIGITAL INPUTS	PROBE PROBES		
AKEC470.508	7" Dokunmatik Ekran (Kan saklama, aşı, kit serum ve ilaç saklama soğutucular için) HACCP Gerçek Zaman Saati Sesli Uyan Donanımı IP65 Koruma (Ön Panel)	7" Touch Screen (For blood bank, vaccination, kit serum and drugs refrigerators) HACCP Real Time Clock Internal Buzzer IP65 Protection (Front Face)				
AKEC470.508.01.01	7" Dokunmatik Ekran Kompresör, eritme, evaporator fan, iç aydınlatma ve alarm yönetimi	7" Touch Screen Controller with Compressor, defrost, evaporator fan, cabinet light and alarm management	5 adet 30 A Kompresör 16 A Eritme 10 A Evaporator Fan 10 A İç Aydınlatma 10 A Alarm	5 units of 30 A Compressor 16 A Defrost 10 A Evaporator Fan 16 A Cabinet Light 10 A Alarm	2 adet 2 units	3 adet 3 units of NTC
AKEC470.508.02.01	7" Dokunmatik Ekran Kompresör, eritme, evaporator fan, kondenser fan, iç aydınlatma ve alarm, yönetimi	7" Touch Screen Controller with Compressor, defrost, evaporator fan, condenser fan, cabinet light and alarm management	6 adet 30 A Kompresör 16 A Eritme 10 A Evaporator Fan 10 A Kondenser Fan 16 A İç Aydınlatma 10 A Alarm	6 units of 30 A Compressor 16 A Defrost 10 A Evaporator Fan 10 A Condenser Fan 16 A Cabinet Light 10 A Alarm	2 adet 2 units	4 adet 4 units of NTC
AKEC470.508.03.01	7" Dokunmatik Ekran Kompresör, eritme, evaporator fan, kondenser fan, iç aydınlatma, alarm ve yardımcı röle çıkış yönetimi	7" Touch Screen Controller with Compressor, defrost, evaporator fan, condenser fan, cabinet light, alarm and auxiliary relay output management	7 adet 30 A Kompresör 16 A Eritme 10 A Evaporator Fan 10 A Kondenser Fan 16 A İç Aydınlatma 10 A Alarm 10 A Yardımcı Çıkış	7 units of 30 A Compressor 16 A Defrost 10 A Evaporator Fan 10 A Condenser Fan 16 A Cabinet Light 10 A Alarm 10 A Aux	2 adet 2 units	6 adet 6 units of NTC

Sıcaklık verilerini depolayabilir  
Ability to store temperatureNem sensörü  
Humidity sensorLokal izleme sistemi  
Local monitoring systemMüşteriye özel logo  
Customer specific logoLED aydınlatmalı dokunmatik buton  
LED illuminated touch buttonEnerji tasarruf sistemi  
Energy saving systemEsnek çalışma voltajı  
Flexible operating voltageEritme yönetimi  
Defrost managementSesli uyan sistemi  
Audible caution systemDarbeye dayanıklı, su geçirmez, ön panel  
Impact resistant, waterproof, front panelUyan aydınlatmaları  
Warning lightsLogo aydınlatması  
Logo illuminationPaket içeriği  
Package ContentMontaj Aparatları  
Mounting Apparatus ✓Kullanma Kılavuzu  
User Manuals ✓Yardımcı Ekipmanlar  
Auxiliary Equipments ✗Minimum Sipariş Miktarı  
Minimum Order Quantity 6 Ad./Pcs

**Advanced Röle Kartı**  
**Advanced I/O Unit**

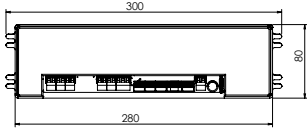
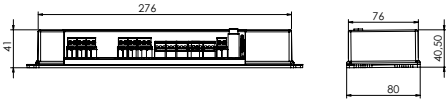

**Basic Röle Kartı**  
**Basic I/O Unit**

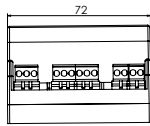
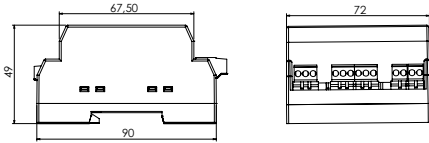

**Advanced Röle Kartı**  
**Advanced I/O Unit**

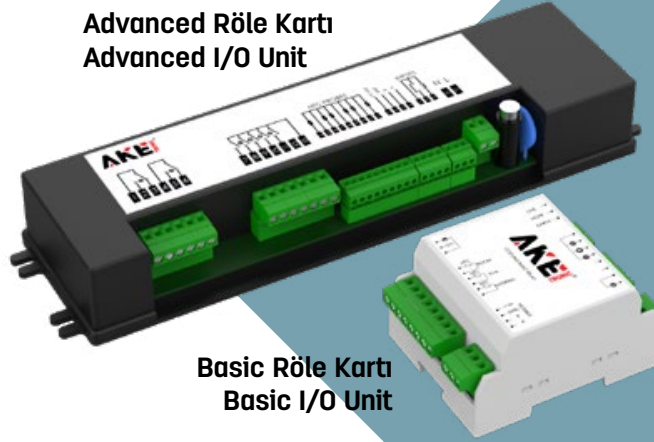

**Basic Röle Kartı**  
**Basic I/O Unit**

**Röle Kartları**  
**I/O Units**

ÖZELLİKLER / ÜRÜNLER SPECIFICATIONS / PRODUCTS	Advanced Röle Kartı Advanced I/O Unit			Basic Röle Kartı Basic I/O Unit			
	AKER024.01.01	AKER024.02.01	AKER024.03.01	AKER025.01.01	AKER025.02.01	AKER025.03.01	
<b>BESLEME VOLTAJI / POWER SUPPLY</b>							
12-24 VAC/DC	12-24 VAC/DC	•	•	•			
230 VAC	230 VAC						
85-305 VAC (SMPS)	85-305 VAC (SMPS)			•	•	•	
<b>ANALOG GİRİŞLER / ANALOG INPUTS</b>							
Kabin Prob (NTC)	Room Probe (NTC)	•	•	•	•	•	
Evaporator Prob (NTC)	Evaporator Probe (NTC)	•	•	•		•	
Kondenser Prob (NTC)	Condenser Probe (NTC)	•	•	•			
Yardımcı Prob 1 (NTC)	Auxiliary Probe 1 (NTC)		•	•			
Yardımcı Prob 2 (NTC)	Auxiliary Probe 2 (NTC)			•			
Yardımcı Prob 3 (NTC)	Auxiliary Probe 3 (NTC)			•			
<b>DİJİTAL GİRİŞLER / DIGITAL INPUTS</b>							
Kapı Anahtar	Door Switch	•	•	•		•	
Yardımcı Dijital Giriş (AUX)	Auxiliary Digital Input (AUX)	•	•	•	•	•	
<b>DİJİTAL ÇIKIŞLAR / DIGITAL OUTPUTS</b>							
Kompresör	Compressor	30A	30A	30A	30A	30A	
Eritme	Defrost	16A	16A	16A		10A	
Evaporator Fanı	Evaporator Fan	10A	10A	10A		10A	
Kondenser Fanı	Condenser Fan		10A	10A			
İç aydınlatma	Cabinet Light	16A	16A	16A	10A	10A	
Alarm	Alarm	10A	10A	10A			
Yardımcı Dijital Çıkış (İç Aydınlatma veya Alarm)	Auxiliary Digital Output (Cabinet Light or Alarm)			10A		10A	
<b>HABERLEŞME / COMMUNICATIONS</b>							
MODBUS RS-485	MODBUS RS-485	•	•	•	•	•	
USB	USB	•	•	•	•	•	
TTL	TTL	•	•	•	•	•	
<b>DİĞER ÖZELLİKLER / OTHER FEATURES</b>							
LOMOS-Lokal İzleme Sistemi	LOMOS-Local Monitoring System	•	•	•	•	•	
<b>YARDIMCI EKİPMANLAR / AUXILIARY EQUIPMENTS</b>							
PTD - Parametre Transfer Cihazı	PTD- Parameter Transfer Device	•	•	•	•	•	
Nem Sensörü Dönüştürücü	Humidity Sensor Converter	•	•	•	•	•	
MC- MODBUS(RS485) Dönüştürücü	MC- MODBUS Converter						
<b>TEKNİK ÖZELLİKLER / TECHNICAL DATA</b>							
Çalışma Sıcaklığı	Operating Temperature	-5.....+55			-5.....+55		
Stoklama Sıcaklığı	Storage Temperature	-30.....+85			-30.....+85		
Bağıl Nem	Relative Humidity	10.....90%(Non condensing)			10.....90%(Non condensing)		
Ölçüm Birimi	Unit of Measure	C/F			C/F		
<b>Fiyat/Price</b>		74 €	76 €	80 €	60 €	64 €	70 €

Paket İçeriği  
Package Content

Montaj Aparatları  
Mounting Apparatus ✓

Kullanma Kılavuzu  
User Manuals ✓

Yardımcı Ekipmanlar  
Auxiliary Equipments ✗

Minimum Sipariş Miktarı  
Minimum Order Quantity 6 Ad./Pcs

## YARDIMCI EKİPMANLAR/AUXILIARY EQUIPMENTS

### MODEL

### FEATURES

AKE.PTD.01  
Parametre Aktarım  
Cihazı  
Parameter  
Transfer Device

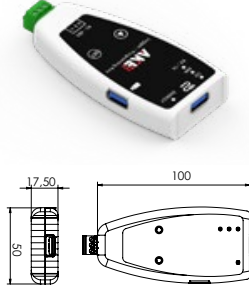

PTD, AKE soğutma kontrol üniteleri arasında parametre aktarımına imkan veren bir program cihazıdır.  
Kaydedilen verilerin USB ile taşınabilir belleğe aktarılmasını sağlar.  
Gerçek Zaman Saati (RTC) kiti olarak kullanılabilir. (Sadece RTC olmayan modeller için)  
Sesli uyan donanım kiti olarak kullanılabilir. (Buzzer olmayan modeller için)

PTD is a program device that allows parameter transfer between AKE controllers for refrigeration.  
It allows transfer of recorded data to flash memory via USB.  
It can be used as RTC conversion kit. (For only non-RTC models)  
It can be used as audible caution hardware kit. (For only non-buzzer models)

AKE.MCK.01  
Modbus Dönüştürme Kiti  
Modbus Converter

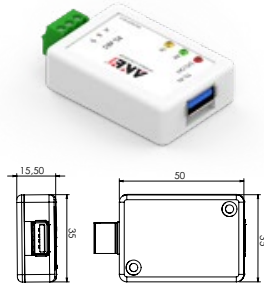

MODBUS haberleşme protokolüne sahip olmayan modeller için dönüştürücü kiti olarak kullanılabilir.  
Lokal İzleme Sistemi için kullanılır.

It can be used as a converter kit for models that do not have MODBUS communication protocol.  
It's used for Local Monitoring System.

AKE.HTS.01  
MODBUS Nem ve  
Sıcaklık Sensörü  
MODBUS Humidity and  
Temperature Sensor

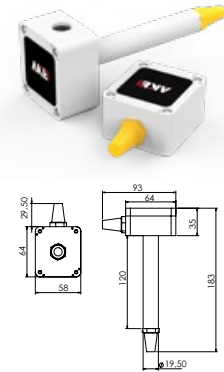

Bağıl Keskinlik Nem Sensörü :  $\pm 5\%$  RH (max), 0-90% RH  
Yüksek Hassasiyetli Sıcaklık Sensörü:  $\pm 1^\circ\text{C}$  (max),  $-10$  to  $85^\circ\text{C}$   
0 to 100% RH çalışma aralığı  
 $-40$  to  $+125^\circ\text{C}$  çalışma aralığı  
Esnek Çalışma Voltajı: (1.9 to 3.6 V)  
Düşük Güç Tüketimi  
150  $\mu\text{A}$  aktif halde iken çekilen akım  
60 nA bekleme halinde iken çekilen akım

Precision Relative Humidity Sensor:  $\pm 5\%$  RH (max), 0-90% RH  
High Accuracy Temperature Sensor:  $\pm 1^\circ\text{C}$  (max),  $-10$  to  $85^\circ\text{C}$   
0 to 100% RH operating range  
 $-40$  to  $+125^\circ\text{C}$  operating range  
Flexible operating voltage: (1.9 to 3.6 V)  
Low Power Consumption  
150  $\mu\text{A}$  active current aktif halde iken çekilen akım  
60 nA standby current bekleme halinde iken çekilen akım

AKE.NTC.01  
NTC



Ölçüm Aralığı:  $-40^\circ\text{C}$  ve  $120^\circ\text{C}$  arası  
Kablo Uzunluğu: 1m-1.5m-2m-3m  
Prob Ölçüsü: 6x30 mm. (QxL)

Measurement Range :  $-40^\circ\text{C}$  to  $120^\circ\text{C}$   
Length of Cable : 1m-1.5m-2m-3m  
Size of Probe : 6x30 mm. (QxL)

AKE.FHK.01  
Fan Hız Kontrolü Ünitesi  
Fan Speed Controller

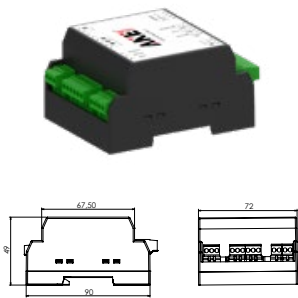

Kademeli hız kontrolü.  
Modbus-rs485 haberleşme protokü.  
Dışardan 0-10v veya 0-20ma giriş ile hız kontrolü.  
Akım okuma ve sınırlama.  
4A-8A-12A modeller mevcuttur.

Speed controlling in steps  
Modbus-rs485 communication protocol  
Speed controlling with 0-10v or 0-20ma input  
Current reading and limiting.  
Models : 4A-8A-16A



TEKNOLOJİ HER YERDE  
**TECHNOLOGY IN EVERYWHERE**



AKETRONİKS Elektronik Bilişim Otomasyon Makine İç ve Dış Ticaret Ltd. Şti.  
Fevzi Çakmak Mh. Ahmet Petekçi Cd. Kobisan Sanayi Sitesi A Blk No:17/O Karatay / KONYA / TURKEY  
Tel : +90 332 239 04 03 • Fax : +90 332 502 17 35  
E-mail : info@aketroniks.com.tr



[www.aketroniks.com.tr](http://www.aketroniks.com.tr)

